



## JETSLIDE system

---

## -OWNER'S MANUAL-

---

[www.candock.com](http://www.candock.com)

[candock@candock.com](mailto:candock@candock.com)

9441, Bourque Blvd.  
Sherbrooke (Qc) J1N 0G2

OFFICE|BUR. **819 847-2599**  
T.FREE|S. FRAIS **1 888 547-2599**  
FAX|TÉLÉC. **819 847-3250**

TABLE OF CONTENT

G2 JETSLIDE	P.3
AIR ASSIST SYSTEM V1 ( AIR BAG )	P.9
AIR ASSIST SYSTEM V2 ( AIR BAG )	P.13
ALUMINUM STIFFENING BEAMS	P.16
“V” PLATE	P.17
SAFETY PLATES ( 1,2 AND 3 CUBES LENGHT ) & LUG CONNECTOR “ <b>JETSLIDE</b> ”	P.18
PWC WINCH	P.19
WINCH JETSLIDE BOAT (MAX 3000PDS/1360KGS)	P.20

**CONFIGURATIONS AND ANCHORING GUIDELINES FOR “PWC” JETSLIDE SYSTEMS**

1-SUGGESTED CONFIGURATIONS: 1-3 BASIC CONFIGURATIONS	P.21
2-ANCHORING:	
2.1-PILINGS	P.22
2.2-ANCHORING STRUTS	P.22
2.3-WALL ANCHORAGES	P.22
2.4-DOCK LEG SUPPORT	P.23
2.5-ROPES AND CLEATS	P.23

**CONFIGURATIONS AND ANCHORING GUIDELINES FOR “BOAT” JETSLIDE SYSTEMS**

1-SUGGESTED CONFIGURATIONS: 1- THE CHART	P.24
2-ANCHORING:	
2.1-PILINGS	P.25
2.2-ANCHORING STRUTS	P.26
2.3-WALL ANCHORAGES	P.27
2.4-COMBINATIONS INCLUDING UNDER WATER ANCHORING POINTS	P.28

IMPORTANT NOTICE P.29

**\*\*\* Note that it is preferable to consult the manual on a COLORED printed version, or directly on your computer screen\*\*\***

\*The following instructions are guidelines to be followed. Candock will not be responsible for damages incurred by the non-compliance to these guide lines. All distributors are required and responsible to provide theoretical and practical training to clients on the complete use of the different dock systems. Candock inc. can not be held responsible in any way for any damages resulting from the fact that the client has not received adequate training.

# IMPORTANT NOTICE

---

Here are some very important details concerning the installation of JetSlide systems for PWC and boats:

**FOLLOWING INSTRUCTIONS ARE GUIDELINES TO BE FOLLOWED AND RESPECTED. CANDOCK IS NOT LIABLE FOR ANY DAMAGES WHATSOEVER, RESULTING OF THE NON COMPLIANCE OF THESE GUIDELINES.**

All distributors are held responsible for giving training to their customers on the complete use of the system (theoretical and practical) with the watercraft of their customer. Candock Inc. will not be held responsible for any damages resulting from the fact that the operator did not receive the adequate training.

With the numerous varieties of boats on the market, it is possible that certain types will not be compatible with our system. Candock Inc. cannot be held responsible for this fact. It is impossible for us to be able to test all the existing types of boats in the world.

Never use the JETSLIDE without adding cubes on its outskirts. ALWAYS abide to the suggested number of cubes, for any system including a JETSLIDE. For example, if we specify that a system "x" requires a single row of cube on the outskirts of the JETSLIDE, this guidance must be followed to ensure optimal efficiency of the system. The only place where you can add "unnecessary" cubes is "in front" of the JETSLIDE and cubes that surround it.

## G2 JETSLIDE

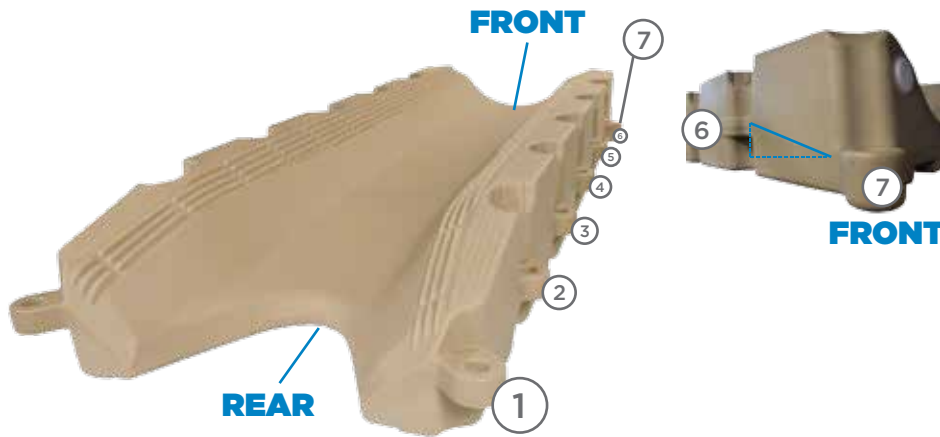

Available colors are GREY and BEIGE  
 Other colors also available upon special request.

**Material/Composition :**

High-density polyethylene resin

**Interior :**

Expanded Styrofoam

**Dimensions :**

L x W : 288 cm (114") x 96 cm (38")  
 H : 38 cm (15")

**Weight :**

68 kg (150lbs)

### TERMINOLOGY

**TABS:** Prominent treated parts surrounding the the JETSLIDE. These tabs (#1 to #6), positioned at the lowest position available on our systems, act as the "female" part of the fastening system between the G2 CUBES, the G2 CONNECTING PINS, and the JETSLIDE. The #7 tab is, in turn, non-treated and is sitting underneath the 6 other tabs. This lower configuration is to allow the combination of 2 JETSLIDES one in front of the other. This lower tab simply act as a support for tab #1 of the second JETSLIDE.

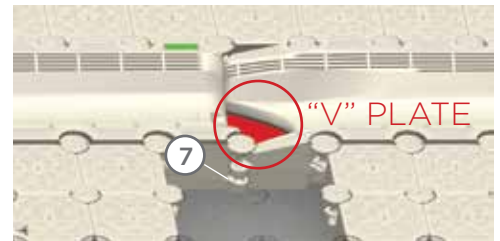

### OVERVIEWS

**MINIMAL CONFIGURATION**

PWC JETSLIDE SYSTEM

**<800LBS**

- 1 x G2 JETSLIDE
- 14 x G2 CUBES
- 12 x G2 CONNECTING PINS
- 2 x CANDOCK SLIDING NUTS
- 14 x CANDOCK LUG CONNECTORS
- 14 x CANDOCK NUTS
- 29 x CANDOCK SPACERS

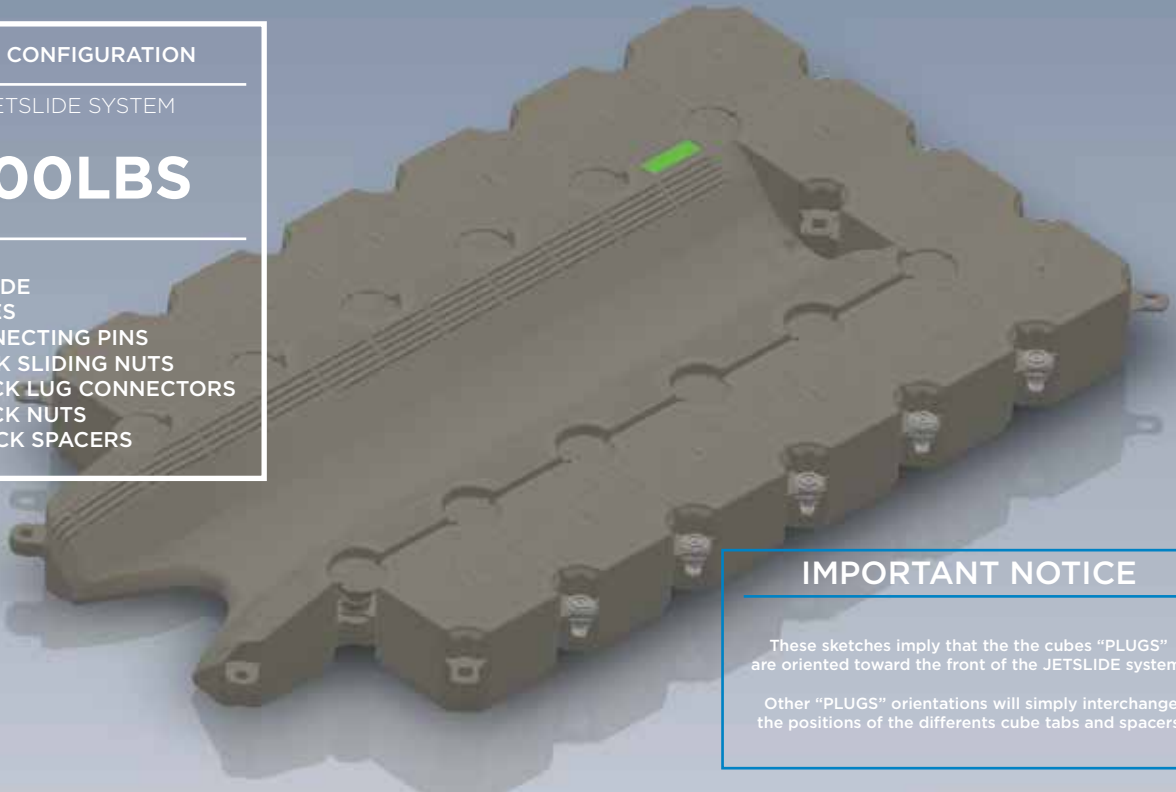

**IMPORTANT NOTICE**

These sketches imply that the the cubes "PLUGS" are oriented toward the front of the JETSLIDE system.

Other "PLUGS" orientations will simply interchange the positions of the differents cube tabs and spacers.

**G2 JETSLIDE ( SEQUENCE )**

# RIGHT SIDE ASSEMBLY

## IMPORTANT NOTICE

These sketches imply that the the cubes "PLUGS" are oriented toward the front of the JETSLIDE system.

Other "PLUGS" orientations will simply interchange the positions of the differents cube tabs and spacers.

1 CANDOCK-SPACER  
(LAYERS 4)

2 CANDOCK-SPACERS  
(LAYERS 3 AND 4)

2 CANDOCK-SPACERS  
(LAYERS 3 AND 4)

2 CANDOCK-SPACERS  
(LAYERS 3 AND 4)

2 CANDOCK-SPACERS  
(LAYERS 3 AND 4)

2+1 CANDOCK SPACERS  
(LAYERS 1,3 AND 4)

JETSLIDE TAB

\*TAB #7 - ALWAYS INSERT A CANDOCK SLIDING NUT AGAINST THE LOWEST TAB AVAILABLE

If additionnal cubes are needed on the outskirts of this "basic assembly", simply proceed following regular [G2 CUBES](#) assembly instructions

# LEFT SIDE ASSEMBLY

\*TAB #7 - ALWAYS INSERT A CANDOCK SLIDING NUT AGAINST THE LOWEST TAB AVAILABLE

— NO CANDOCK SPACER

— 2 CANDOCK SPACERS  
(LAYERS 1 AND 2)

— 2 CANDOCK SPACERS  
(LAYERS 1 AND 2)

— 2 CANDOCK SPACERS  
(LAYERS 1 AND 2)

— 2 CANDOCK SPACERS  
(LAYERS 1 AND 2)

2+1 CANDOCK SPACERS  
(LAYERS 1,2 AND 4)

JETSLIDE TAB

## IMPORTANT NOTICE

These sketches imply that the the cubes "PLUGS" are oriented toward the front of the JETSLIDE system.

Other "PLUGS" orientations will simply interchange the positions of the differents cube tabs and spacers.

If additionnal cubes are needed on the outskirts of this "basic assembly", simply proceed following regular [G2 CUBES](#) assembly instructions

G2 JETSLIDE ( SEQUENCE )

# ASSEMBLY WITH "CLOSED" CORNER CUBE

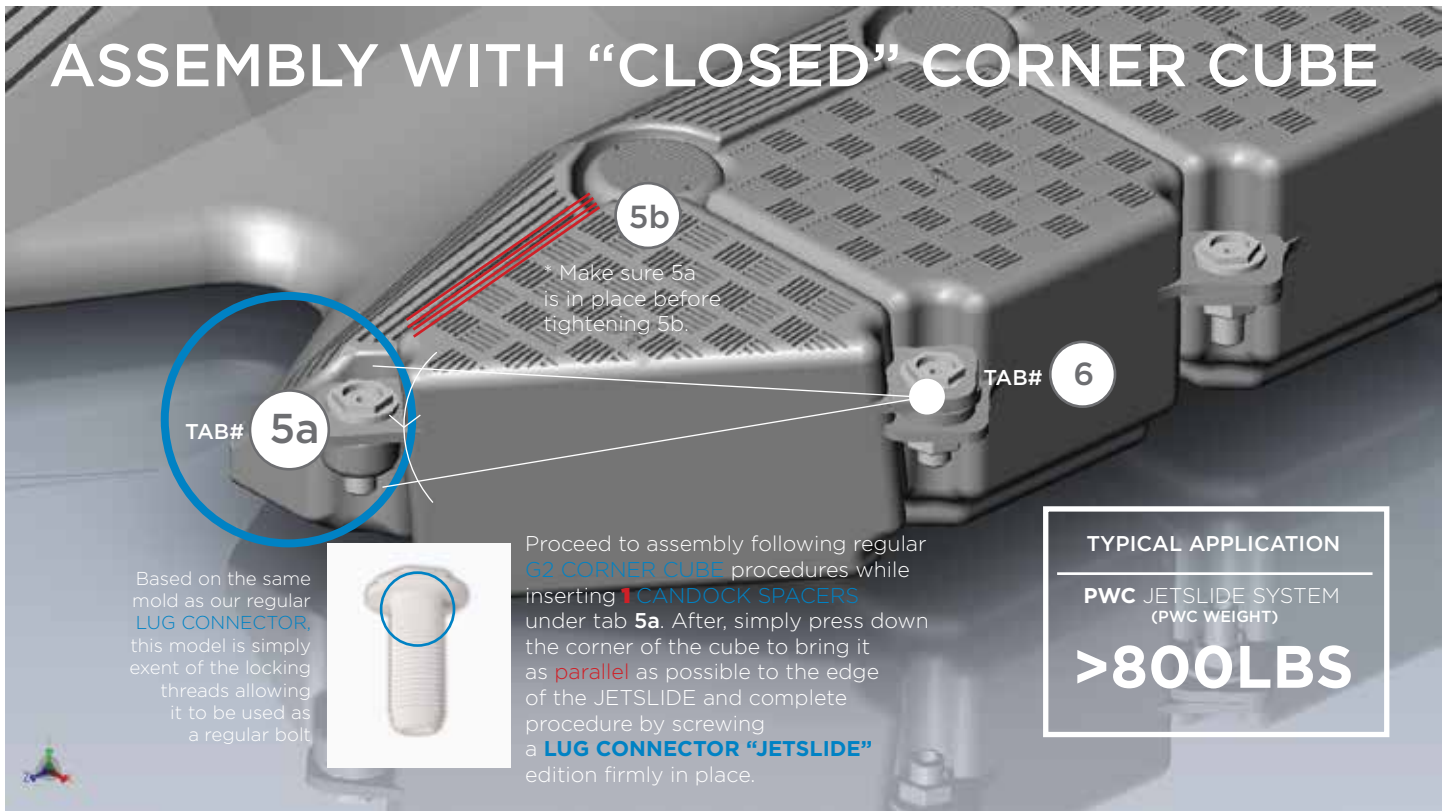

TAB# **5a**

Based on the same mold as our regular LUG CONNECTOR, this model is simply an extent of the locking threads allowing it to be used as a regular bolt.



Proceed to assembly following regular G2 CORNER CUBE procedures while inserting a **CANDOCK SPACERS** under tab **5a**. After, simply press down the corner of the cube to bring it as **parallel** as possible to the edge of the JETSLIDE and complete procedure by screwing a **LUG CONNECTOR "JETSLIDE"** edition firmly in place.

**5b**

\* Make sure 5a is in place before tightening 5b.

TAB# **6**

TYPICAL APPLICATION

PWC JETSLIDE SYSTEM  
 (PWC WEIGHT)

**>800LBS**

# ASSEMBLY WITH "OPEN" CORNER CUBE

Proceed to assembly following regular G2 CORNER CUBE assembly guidelines. Make sure to include any needed SPACERS as you go.



TYPICAL APPLICATION

JETSLIDE SYSTEM

**BOAT**

## G2 JETSLIDE ( SEQUENCE )

### ASSEMBLY

#### TIPS:

- Assemble on a flat surface rather than water. It will be easier that way.
- Assemble the cubes around the JetSlide. If you attach it to a dock, make sure the plugs are facing the SAME DIRECTION. If your JetSlide is an independent unit, black plugs must be oriented toward the front of your unit.

#### PROCEDURE:

1-Place **CANDOCK SPACERS** before inserting the connecting pins. When the cubes are put together, the tabs will nest on top of each other. The tabs are numbered from 1 to 4 for the regular **G2 CUBES** ( "1" being the lowest and "4" the highest). The **JETSLIDE's** tabs (# "0") are placed just below the tab #1 of the cubes. You must insert spacers at the right positions to generate the equivalent of 4 tabs on top of the **JETSLIDE's** tabs.

2-Insert spacers as you position the **G2 CUBES** around **JETSLIDE**.

3-Insert **G2 CONNECTING PINS** and initiate the screwing process by hand. This will prevent pre-mature wear and tear..

4-When the pins are properly inserted, proceed by screwing manually and/or mechanically with our pre-destined tools. Either the **KEY FOR G2 PIN "COMBO PACK"** or the regular **G2 KEY FOR PINS**.

5-Make sure to securely tight the **G2 CONNECTING PINS** until snug, without over tightening them

4) In **POSITION ①** , the connecting pins require a **CANDOCK SLIDING NUTS**

because the **JETSLIDE** has no threaded tab at those corners. Place a **CANDOCK SLIDING NUT** on the lowest tab available.

5) Install the exterior **CANDOCK LUG CONNECTORS + NUTS** assembly around the **JETSLIDE** system and screw them using the proper tool.

**Note:** Usually, you should never have more than 2 tabs or more than 2 **CANDOCK SPACERS** to install.

## IMPORTANT NOTICE

These sketches imply that the the cubes "PLUGS" are oriented toward the front of the **JETSLIDE** system.

Other "PLUGS" orientations will simply interchange the positions of the differents cube tabs and spacers.

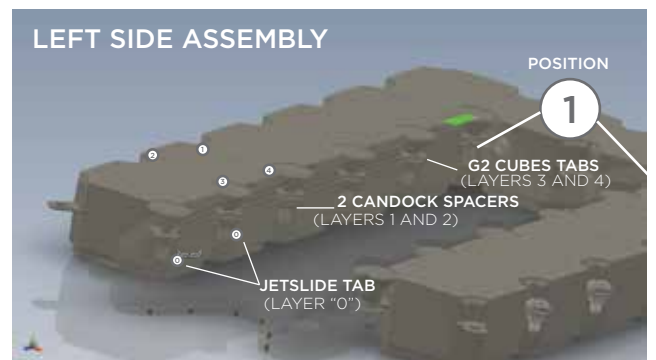
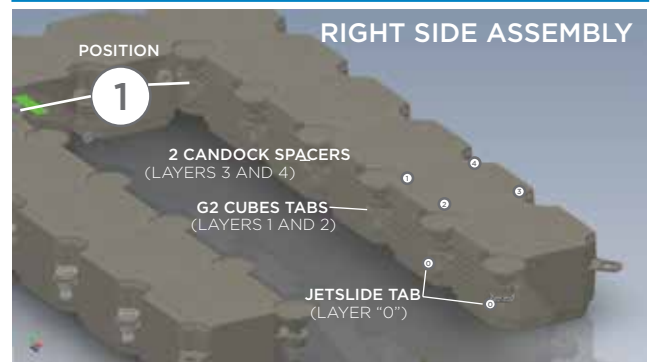

IF MULTIPLE JETSLIDE SYSTEM IS REQUIRED, PROCEED WITH THE SAME BASIC GUIDELINES WHILE INSURING THAT THE "LINKED" JETSLIDES ARE INITIALLY WELL ALIGNED TO INSURE EASY ASSEMBLY.

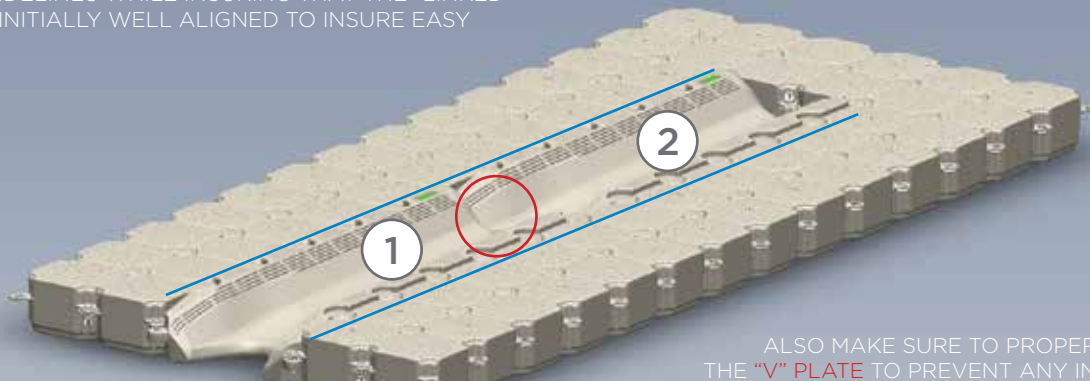

ALSO MAKE SURE TO PROPERLY INSTALL THE "V" PLATE TO PREVENT ANY IN ACCIDENT. THIS PLATE IS ONLY THERE TO PREVENT SOMEONE FROM FALLING IN THE HOLE THAT IS CREATED BETWEEN THE 2 JETSLIDES. ( SEE INSTRUCTIONS ON PAGE 23 )

## G2 JETSLIDE ( SEQUENCE )

---

### OPERATING A WATER-CRAFT WITH THE JETSLIDE

---

#### GOING UP THE SYSTEM ( BOAT AND/OR PWC )

**PWC:** Approach the JetSlide at idle, keeping the craft straight and centred with the JetSlide. When the bow of the craft will be in contact with the JetSlide, give small throttle strokes that will make the craft align with the JetSlide. When the craft is in line with the JetSlide, throttle in slowly. After a few tries, you will rapidly develop a feel of how much throttle you have to use to reach final position on the JetSlide

**BOAT:** engine must be trimmed down fully during the entering procedures and the depth of water at the back of the system must be 3' /1m minimum at all time to avoid damage to the boat. Increase throttle power until the boat is fully up on the system. When the engine gets in contact with the JetSlide, you will feel the craft stopping. You must immediately throttle down. This indicates that the craft is at final resting position. Entering the unit at high speed may damage the unit. We recommend, at first, that you try at slow speeds until you reach the correct speed. If the boat gets on the system but is not all the way in, you can continue throttling progressively until the boat reaches final resting position. Be careful, boarding at high speed can be dangerous.

**NOTE:** It is recommended to secure the craft to a cleat in order to prevent the craft from sliding back into the water accidentally. The craft can be locked to the JetSlide with a chain when you are not using it. Ask your dealer for details.

#### GOING DOWN THE SYSTEM

**PWC:**To go back into the water, take a standing position on your PWC and generate a backward movement by using your lower back and arms, pumping backwards rapidly until the PWC starts sliding back into the water. The procedure is easier when the PWC is wet. You can also stand up at the back of your PWC, grab the handle of the seat and transfer your weight back. The easiest way to return to water is to keep the front of the PWC in one hand and the handle of the other and then push gently. Be vigilant, because at some point, your PWC will start to go down by itself. At this point, you will have to get on it if you do not want your watercraft in the water without you.

**BOAT:** For a boat, put the engine in reverse and increase throttle until craft starts to go down by itself. It helps if you wet the system, especially if the boat was not used for a couple of days. It might be necessary to give a good throttle stroke to start the movement and then throttle down. For a Jet boat, the air assisted system will be required, no matter the weight of the boat.

## WARNINGS & SPECIAL INSTRUCTIONS

---

1- Like all JetSlide installations, the system should not be installed in areas subject to waves of more than 0.75m / 2ft regularly. We recommend an installation in a protected area.

2-The installation of multiple PWC JetSlides side to side is possible, but a minimum of 2 rows of cubes is suggested between each JetSlide. An installation with only one row is possible, but there is a risk of damaging the machines and, therefore, the resulting damages will not be covered by the manufacturers warranty. Contact Candock for more information.

3-The handling of several JetSlides assembled in series by lifting (for winterizing by using a crane for example) is strictly forbidden. The excessive inflections will break the tabs of the JetSlide and the resulting damage will not be covered by the warranty. Contact Candock for more information.

4-The depth of water at the back of the system must be 1m / 3' minimum at all time to avoid damage to the boats.

5-Riveted hulls can damage the JetSlide. "Step hull" crafts are not suggested if used on a double JETSLIDE configuration.

6-Surface can be slippery when the system is wet.

7-The capacity of the JetSlide may change depending on the type of assembly, accessories and according to the weight distribution of the engines within the the watercraft.



## G2 JETSLIDE ( SEQUENCE )

---

### WARNINGS & SPECIAL INSTRUCTIONS

---

8-Please note that some boats have cooling intakes for the engine which are located directly on the boats hull .These intakes need to be under the water line mark when the engine is running. **CANDOCK INC. WILL NOT TAKE ANY RESPONSABILITY FOR ANY TYPE OF DAMAGE TO A BOAT RESULTING FROM THIS. IT IS THE RESPONSABILITY OF THE DISTRIBUTOR TO MAKE SURE THAT THIS IS VERIFIED BEFORE SELLING THE INSTALLATION TO THE CLIENT.** We recommend that you inform your clients of that even if you are sure that the intake will be in the water.

9-The fact of removing cubes at the back of the system to lower the back of the system closer to the water could exert excessive pressure on the back tabs of the Jetslide and may cause damage which will not be covered by the warranty.

10-All distributors are held responsible for giving training to the customers on the complete use of the system, theoretical and practical with the watercraft of the customer. Candock Inc. will not be held responsible for any damages resulting from the fact that the operator did not receive the adequate training.

11-The boats and personnal water crafts must be completely mounted on the Jetslide at all time. A craft left on the Jetslide in a position where the major part of the weight is left on the back, could exert excessive pressure on the back tabs of the Jetslide and may cause damage which will not be covered by the warranty.

12-The installation of multiple BOAT Jetslides side to side is possible, but no rows of cubes should be removed with the aim of saving space. Moreover the totality of the back Jetslide must be left free to be able to go up and down. Therefore, it must not be connected to the adjacent systems.

13-It is normal that a certain wear of the JetSlide appears at the points of contact where the boat exerts more pressure.

14-All Jetslides produced after the November 1st, 2009 are now filled with foam making them unsinkable.

15-We make a point of specifying that any damages caused by the keel of motors or the propellers will not be covered by our warranty.

16-All systems destined for boats of more than 3000lbs/1360kgs ( propeller or turbine powered) require the air assisted system  
NOTE: In certain cases, a winch can be necessary to push the boat back in the water. This may void the neccessity of the air assisted system. Any damage resulting from non-utilization of this winch will not be covered by the warranty.  
(see specific instructions)

17-Stiffening beams may be required for your configuration, any damages resulting from non-utilization will not be covered by the warranty. (see specific instructions)\*Only the bams provided by Candock inc. are approved.

18-With the numerous varieties of boats on the market, it is possible that certain types will not be compatible with our system. Candock Inc. cannot be held responsible for this fact. It is impossible for us to be able to test all the existing types of boats in the world.

## AIR ASSIST SYSTEM V1 FOR CRAFTS WEIGHING OVER 3000lbs / 1365kg ( AIR BAG )

Available box colors are GREY and BEIGE.  
 Available bag color is black.

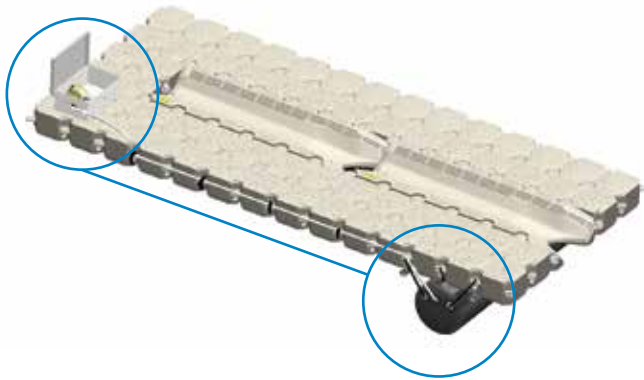

MINIMUM WATER DEPTH FOR SAFE OPERATION: **3 FEET**

### Material/Composition :

High-density polyethylene resin. ( BOX )  
 Military grade PVC ( BAG )  
 Ballistic Nylon ( SLEEVE )

### Dimensions :

Box: 20" x 30" x 11"  
 51cm x 76cm x 28cm  
 Bag: 9.5' , diameter : 28"

### Displacement of the bag :

1250lbs / 570kgs

### Included items in the DOCK BOX:

- 1 Air bag
- 12 fastening straps
- 1 G2 FASTENING PIN
- 1 Air hose ( 27 feet / 8.3 meters )
- 1 Instruction Manual
- 1 Air pump

### Other mandatory products

**needed to install the AIR ASSIST ( not included ):**

- 2 Aluminum stiffening beams
- 1 Deep cycle 12 volts marine grade battery.

### Other products that may be

**needed to install the AIR ASSIST ( not included ) :**

- SAFETY PLATES ( 1,2 or 3 cubes long )
- "V" PLATE
- Additional aluminum stiffening beam(s)
- Air hose extensions

## TERMINOLOGY

AIR BAG + FASTENING STRAPS:



AIR PUMP:



AIR HOSE:



## ASSEMBLY PROCEDURE

### 1-DOCK BOX INSTALLATION

The Dock Box comes with fixation pin and hardware in order to fix the Dock Box to the Candock docks. With a Candock key, remove a pin of your Candock dock where you want to position the Dock Box and replace it by the fixation pin.

Pass the rod of the pin through the center hole of the Dock Box, place hardware (nut and washer) and tighten everything to ensure a good fixation of the Dock Box.

The pipe coming out the Dock Box should ideally point towards the rear of your system where you will install the airbag.

Now, the Dock Box is installed on the Candock dock and will not fall in the water.

It is possible to position the Dock Box on the shore or on another floating surface along the Candock dock, but Candock disclaims any responsibility for the quality of the fixation of the Dock Box in this situation.

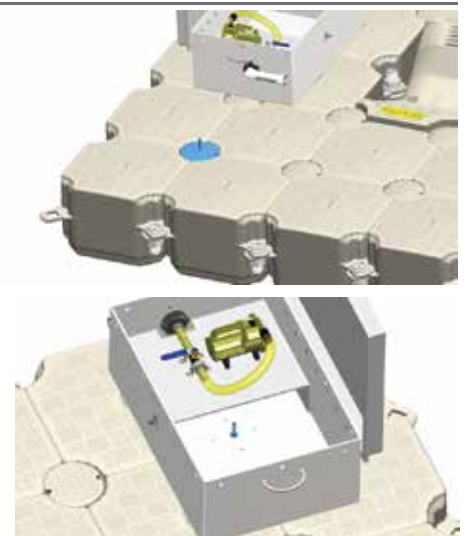

## AIR ASSIST SYSTEM V1 FOR CRAFTS WEIGHING OVER 3000lbs / 1365kg ( AIR BAG )

### ASSEMBLY PROCEDURE

#### 2- AIR BAG INSTALLATION PROCEDURE

Before installing the airbag, make sure that the Candock Dock has 2 stiffening beams placed as shown in the picture a side.  
**SEE PROPER MODIFIED STIFFENING BEAMS INSTALLATION PROCEDURE.**

These beams are essential to ensure good stability of your Candock dock and optimum efficiency of yours Air ASSIST system. If your platform is not equipped with those beams, please refer to your Candock distributor.

Install the 6 straps provided on the rings of the bag. They will then be used to hold the bag in place under the system. To ensure that the bag is not twisted, use the color codes of the starps so that these are fixed to the same rings, on both sides of the bag. (Left / right). Make sure the straps red are positionned at the same place on both sides of the bag, and so on for the yellow and black straps.

Before sliding the airbag under the dock, do not forget to connect the hose supplied with the airbag, to ensure that water wont get into the airbag during the operation. Connect the other end of the hose to the Dock Box.

Attach a rope to the airbag on the opposite side of the hose, and slide it under your Candock dock between stiffening the beams. Then, slowly pull the rope until you see the airbag. To ensure you do not pull the airbag too much, put the side straps around the rods that hold the stiffening beams that are on the other side of the system.  
**(The HOSE side )**

Once the airbag is in place, put the **straps** on the other side of the Candock dock without tightening the side straps. Also place the center straps by inserting them in the **CANDOCK LUG CONNECTOR**. Use the front strap of the airbag and the 4 remaining straps to secure the hose along the dock by passing the strap around the pipe and into the white bolts. Make sure the straps are not too tight (**the straps attached to the central ring must be tight**), fully inflate the airbag (**see operating instructions**). Once the airbag is fully inflated, tighten the remaining straps. These straps prevent forward/backward movement of the airbag once inflated. \*The straps should be loose when the airbag is deflated. \*\*Caution, do not over tighten the straps, this could cause damage to the retaining rings on the airbag and straps during the inflation process. \*\*\*Once bag is fully inflated, it must be perfectly centered between the beams.

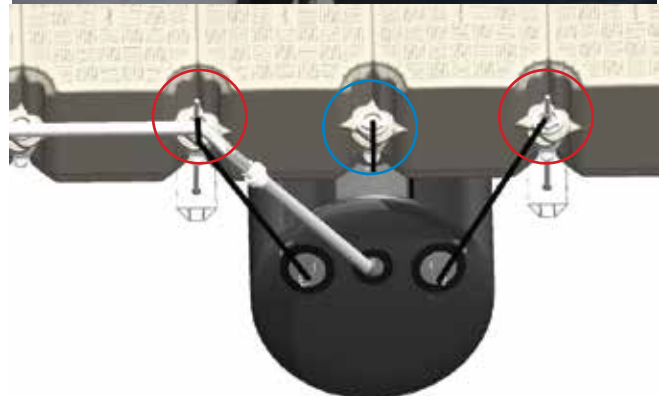
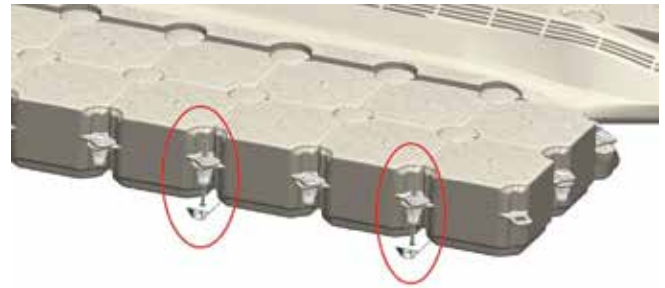

**AIR ASSIST SYSTEM V1 FOR CRAFTS WEIGHING OVER 3000lbs / 1365kg ( AIR BAG )**

ASSEMBLY PROCEDURE

2- AIR BAG INSTALLATION PROCEDURE (SEQUENCE)

There is also two straps that are wider than the others. These straps should be installed around the airbag before it is slipped under the dock. Due to excessive water displacement exerted by some boats when backing off into the water, these straps prevent an overload on the other straps that could break. You must pass the straps around the airbag and once it is in place and the other straps are in position. Inflate the airbag and then place the straps around the screw that attaches the corner cube to the Jetslide as in the following pictures.

*\*Caution, tighten the straps to their maximum only when the system is free of load and when the airbag is fully inflated.*

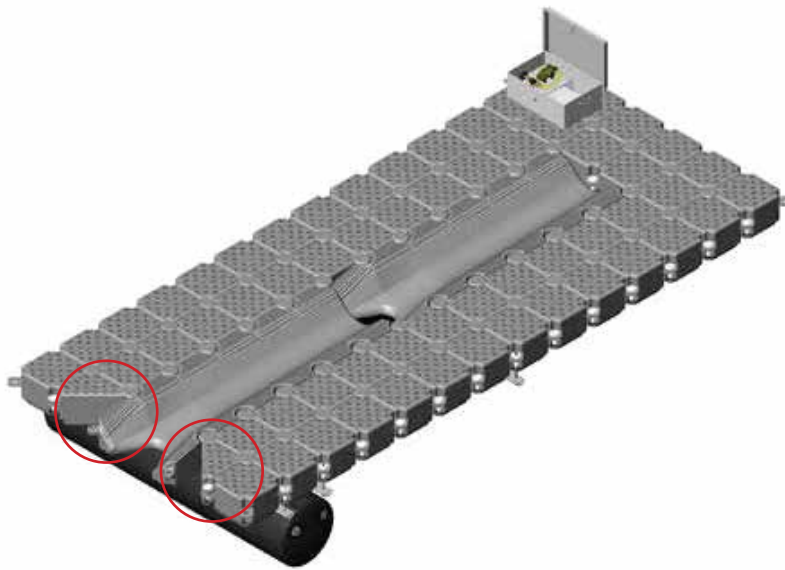

2- PUMP AND BATTERY INSTALLATION

The system is designed to be powered by a 12 V battery (not included). Just put the battery in the Dock Box and connect to the pump using the alligator clips of the pump. We recommend using a solar panel or charge keeper (not included) to maintain battery charge. For more information, please refer to your Candock distributor.

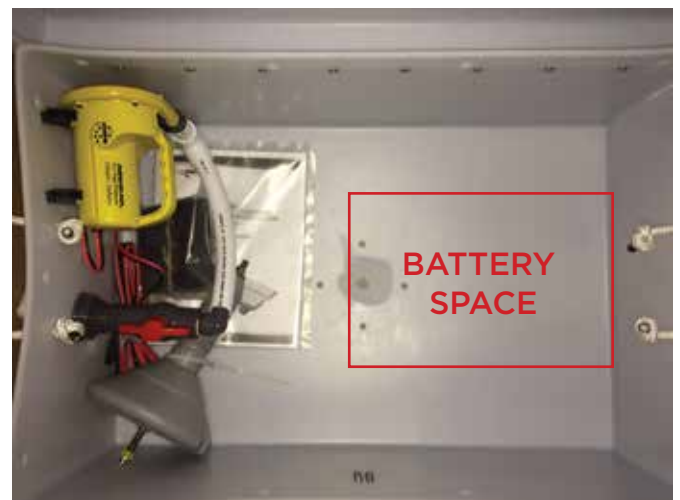

## AIR ASSIST SYSTEM V1 FOR CRAFTS WEIGHING OVER 3000lbs / 1365kg ( AIR BAG )

---

### OPERATING INSTRUCTIONS

---

#### 1- INFLATE

Once your boat is on the JetSlide (See instruction for use of Candock JetSlides), stop the engine and go on the dock. For security reasons, it is always better to secure the boat to your Candock dock using a rope. Open the Dock Box and rotate the valve handles to open it. Then turn on the pump until the airbag is fully inflated and / or until your boat is completely out of the water. As an indication, the sound of the pump changes when the airbag is inflated. Once the airbag is inflated, put the valve into the closed position and stop the pump.

**\*Caution: DO NOT RUN THE PUMP AFTER THE AIRBAG IS INFLATED OR MORE THAN 10 MINUTES, IT MAY DAMAGE THE PUMP. IF AFTER 5 MIN, THE AIRBAG IS NOT FULLY INFLATED OR IF THE BOAT IS NOT COMPLETELY OUT OF WATER, PLEASE CONTACT YOUR CANDOCK DISTRIBUTOR.**

#### 2- DEFLATE

To deflate the airbag, simply put the valve in the open position and allow the airbag to deflate under the weight of your boat. REMEMBER: CLOSE YOUR DOCK BOX AFTER EACH USE OF YOUR CANDOCK AIR ASSIST SYSTEM.

#### 3- MAINTENANCE

-During winter, or if you do not use the pump for a long time, simply disconnect the battery and store in a dry place.

-The airbag and the protection bag should be cleaned with fresh water annually. These 2 components can be cleaned with a soft brush.

-Test the Air ASSIST system once a year with soap and water to prevent leaks and inspect to see if there is no premature damage.

-When you remove the airbag for maintenance, make sure there is no water inside. If there are, remove it. Water inside the airbag can mean leak or puncture.

-Remove the bag and beams for winter if you have ice formation.

#### 4- WARRANTY

Candock offers a 2 years limited warranty on the airbag and 1 year on the Dock Box and the Hose against manufacturing defects from the purchasing date. The warranty applies only to the original owner and applies only on airbags purchased and registered. The warranty is not transferable. This contractual warranty is limited to the replacement or repair of the airbag at Candock's sole discretion, of any defective products that are acknowledged by Candock to be defective, at no charge for material or labour. Transport costs, both in-bound & out-bound, insurance, customs duties, and any other charges are the sole responsibility of the Purchaser. Candock reserves the right to replace the product with a comparable or reconditioned product at its discretion.

#### EXCLUSIONS FROM THE PRESENT WARRANTY

Improper or negligent use of the product, accidents, improper towing, holes, perforations and abrasion, excessive wave action, deterioration, wear & tear, discoloration, deformation, fading, ageing from normal use of either the fabric or component parts, any modifications or alterations of the product that adversely affect the product to perform as designed. To exercise your rights under this warranty, you must contact Candock within 30 days of detection of the defect, either by email, by phone or by letter. The final decision concerning the repairs will be made by Candock after inspection of the tube.

## AIR ASSIST SYSTEM V2 FOR CRAFTS WEIGHING OVER 3000lbs / 1365kg ( AIR BAG )

Available box colors are GREY and BEIGE.  
 Available bag color is black.

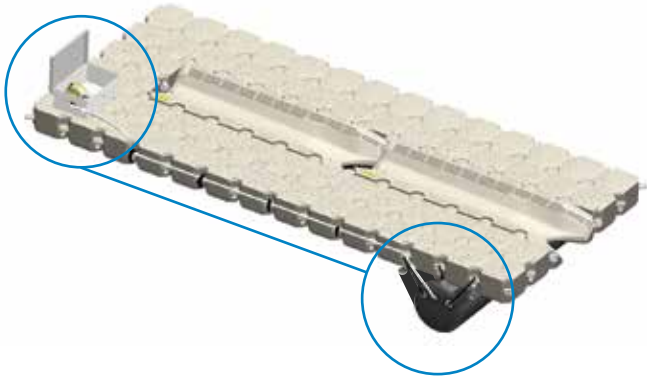

### Material/Composition :

High-density polyethylene resin. ( BOX )  
 Military grade PVC ( BAG )  
 Ballistic Nylon ( SLEEVE )

### Dimensions :

Box: 20" x 30" x 11"  
 51cm x 76cm x 28cm  
 Bag: 9.5' , diameter : 28"

### Displacement of the bag :

1250lbs / 570kgs

### Included items in the DOCK BOX:

- 1 Air bag
- 1 Air bag sleeve
- 1 G2 FASTENING PIN
- 1 Air hose ( 27 feet / 8.3 meters )
- 1 Instruction Manual
- 1 Air pump

### Other mandatory products needed to install the AIR ASSIST ( not included ) :

- 2 Aluminum stiffening beams
- 1 Deep cycle 12 volts marine grade battery.

### Other products that may be needed to install the AIR ASSIST ( not included ) :

- SAFETY PLATES ( 1,2 or 3 cubes long )
- "V" PLATE
- Additional aluminum stiffening beam(s)
- Air hose extensions

MINIMUM WATER DEPTH FOR SAFE OPERATION: **3 FEET**

## TERMINOLOGY

AIR BAG:



AIR BAG SLEEVE:



AIR HOSE:



AIR PUMP:



## ASSEMBLY PROCEDURE

### 1-DOCK BOX INSTALLATION

The Dock Box comes with fixation pin and hardware in order to fix the Dock Box to the Candock docks. With a Candock key, remove a pin of your Candock dock where you want to position the Dock Box and replace it by the fixation pin.

Pass the rod of the pin through the center hole of the Dock Box, place hardware (nut and washer) and tighten everything to ensure a good fixation of the Dock Box.

The pipe coming out the Dock Box should ideally point towards the rear of your system where you will install the airbag.

Now, the Dock Box is installed on the Candock dock and will not fall in the water.

It is possible to position the Dock Box on the shore or on another floating surface along the Candock dock, but Candock disclaims any responsibility for the quality of the fixation of the Dock Box in that situation.

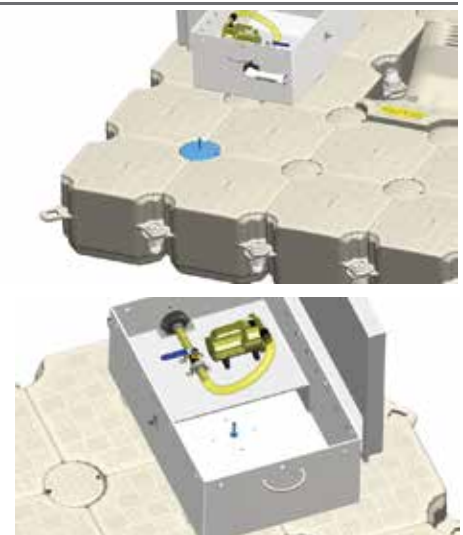

## AIR ASSIST SYSTEM V2 FOR CRAFTS WEIGHING OVER 3000lbs / 1365kg ( AIR BAG )

### ASSEMBLY PROCEDURE

#### 2- AIR BAG INSTALLATION PROCEDURE

Start by inserting the 2 stiffening beams into the **designated sleeves** that are found on each side of the bag sleeve. Using 4 separate ropes, secure each end the beams by tying a nut in the holes at each ends.

Before sliding the airbag under the dock, do not forget to connect the **hose** supplied with the airbag, to ensure that water wont get into the airbag during the operation. Connect the other end of the hose to the Dock Box.

Once all connections are made and ropes are attached, simply slide the whole assembly underneath the system starting from the rear. Make sure that the beams are aligned between cube row **1 & 2** and **3 & 4**. Once alligned, secure each beams to the cubes using supplied hardware and using proper tools. Be careful not to drop the assembly when un-tying the ropes from the beams.

**SEE PROPER STIFFENING BEAMS INSTALLATION PROCEDURE.**

Once the airbag is in place, Use the 4 remaining straps to secure the hose along the dock by passing the strap around the pipe and into the white bolts.

To validate assembly, completely inflate the bag and make sure there are no abnormalities or malfunctions. (**see operating instructions**).

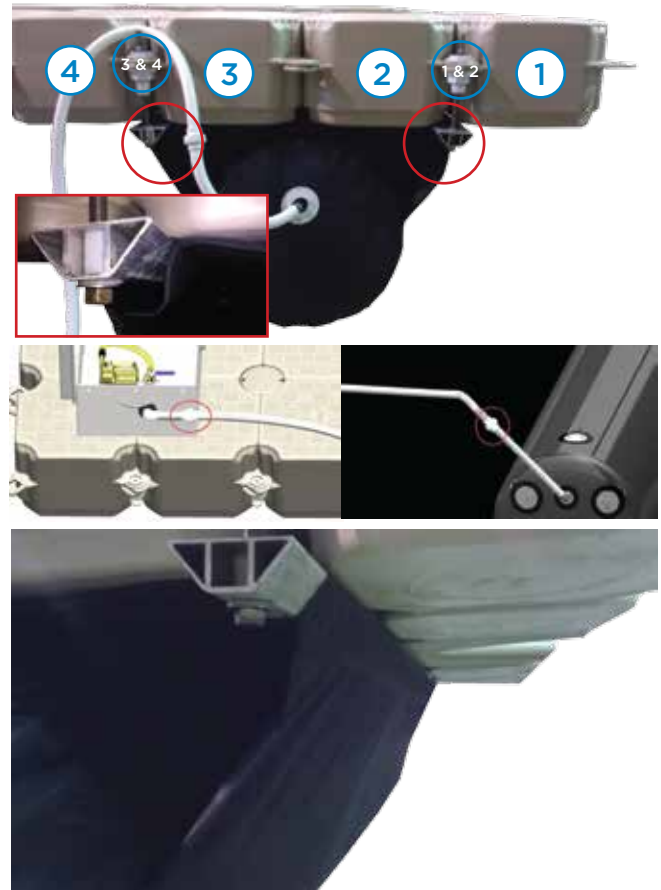

#### 2- PUMP AND BATTERY INSTALLATION

The system is designed to be powered by a 12 V battery (not included). Just put the battery in the Dock Box and connect to the pump using the alligator clips of the pump. We recommend using a solar panel or charge keeper (not included) to maintain battery charge. For more information, please refer to your Candock distributor.

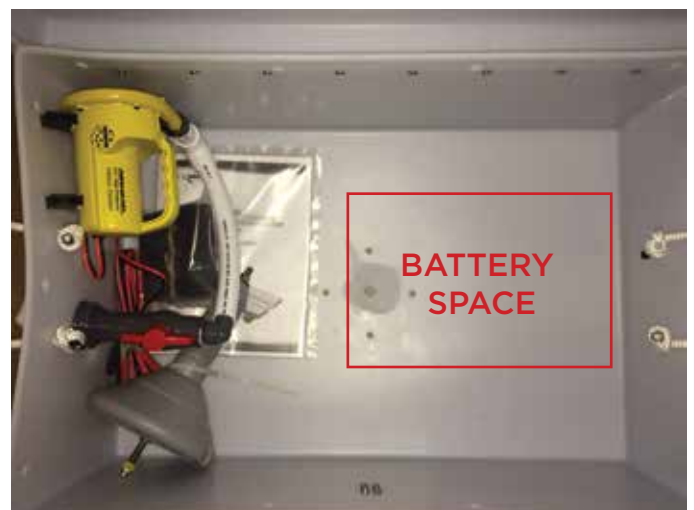

## AIR ASSIST SYSTEM V2 FOR CRAFTS WEIGHING OVER 3000lbs / 1365kg ( AIR BAG )

---

### OPERATING INSTRUCTIONS

---

#### 1- INFLATE

Once your boat is on the JetSlide (See instruction for use of Candock JetSlides), stop the engine and go on the dock. For security reasons, it is always better to secure the boat to your Candock dock using a rope. Open the Dock Box and rotate the valve handles to open it. Then turn on the pump until the airbag is fully inflated and / or until your boat is completely out of the water. As an indication, the sound of the pump changes when the airbag is inflated. Once the airbag is inflated, put the valve into the closed position and stop the pump.

**\*Caution: DO NOT RUN THE PUMP AFTER THE AIRBAG IS INFLATED OR MORE THAN 10 MINUTES, IT MAY DAMAGE THE PUMP. IF AFTER 5 MIN, THE AIRBAG IS NOT FULLY INFLATED OR IF THE BOAT IS NOT COMPLETELY OUT OF WATER, PLEASE CONTACT YOUR CANDOCK DISTRIBUTOR.**

#### 2- DEFLATE

To deflate the airbag, simply put the valve in the open position and allow the airbag to deflate under the weight of your boat. REMEMBER: CLOSE YOUR DOCK BOX AFTER EACH USE OF YOUR CANDOCK AIR ASSIST SYSTEM.

#### 3- MAINTENANCE

-During winter, or if you do not use the pump for a long time, simply disconnect the battery and store in a dry place.

-The airbag and bag sleeve should be cleaned with fresh water annually. These 2 components can be cleaned with a soft brush.

-Test the Air ASSIST system once a year with soap and water to prevent leaks and inspect to see if there is no premature damage.

-When you remove the airbag for maintenance, make sure there is no water inside. If there are, remove it. Water inside the airbag can mean leak or puncture.

-Remove the bag and beams for winter if you have ice formation.

#### 4- WARRANTY

Candock offers a 2 years limited warranty on the airbag and 1 year on the Dock Box and the Hose against manufacturing defects from the purchasing date. The warranty applies only to the original owner and applies only on airbags purchased and registered. The warranty is not transferable. This contractual warranty is limited to the replacement or repair of the airbag at Candock's sole discretion, of any defective products that are acknowledged by Candock to be defective, at no charge for material or labour. Transport costs, both in-bound & out-bound, insurance, customs duties, and any other charges are the sole responsibility of the Purchaser. Candock reserves the right to replace the product with a comparable or reconditioned product at its discretion.

#### EXCLUSIONS FROM THE PRESENT WARRANTY

Improper or negligent use of the product, accidents, improper towing, holes, perforations and abrasion, excessive wave action, deterioration, wear & tear, discoloration, deformation, fading, ageing from normal use of either the fabric or component parts, any modifications or alterations of the product that adversely affect the product to perform as designed. To exercise your rights under this warranty, you must contact Candock within 30 days of detection of the defect, either by email, by phone or by letter. The final decision concerning the repairs will be made by Candock after inspection of the tube.



## ALUMINUM STIFFENING BEAMS

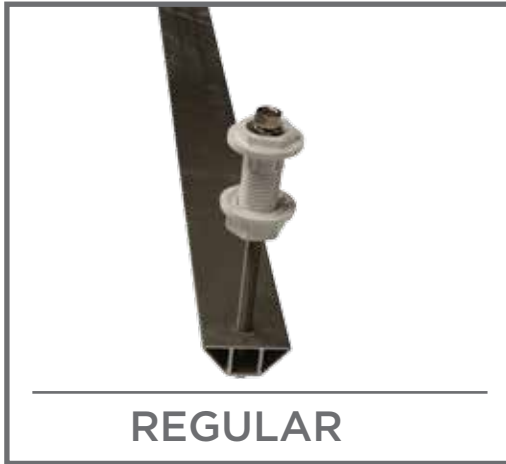

**Material/Composition :**

Aluminum and stainless steel

**Dimensions :**

L : 117" or 155"

**Needed tools :**

15/16" key wrench

Key for nut

or

Ratchet key for nut + ratchet tool

**Needed accessories**

**(sold separately) :**

2 CANDOCK LUG CONNECTOR

2 CANDOCK NUT

## OVERVIEWS

To stiffen your JetSlide system and minimize the lifting of the cubes around the system, a stiffening beam system was designed. The positioning of the beams is not optional. These should always be used when recommended and the use of bars other than those provided by Candock is prohibited unless written permission from Candock. The first bar is always installed between the 1st and 2nd row of cubes in the back. The 2nd bar is installed between the 3rd and 4th row of cubes. In order to prevent the lifting of the cubes on the sides, more bars could be required, install them where needed.

**THE RULE OF THUMB: 1 BEAM EVERY 1000LBS**

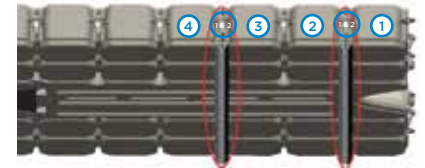

## ASSEMBLY PROCEDURE ( 2 INSTALLERS ARE SUGGESTED FOR THIS PROCEDURE )

1-Initiate the process by installing the [CANDOCK LUG CONNECTORS](#) and [CANDOCK NUTS](#) to every tabs you will later install the beams left and right sides ). Secure the latter following the procedure found in the [BASIC PRODUCTS OWNER'S MANUAL](#)

3-Holding the very end of the threaded rods, simply slide the BEAM underneath the system starting from the rear. Make sure to install the beams that will be at the front of the system and make your way to the back with the subsequent beams.

4-Once aligned, secure the beam to the [CANDOCK LUG CONNECTORS](#) with the hardware kit supplied with the bars. Pass the threaded rode through [CANDOCK LUG CONNECTORS](#) and then place the washer, lock washer and nut.

5-Complete installation by ajusting the beam position for it to be perfectly horizontal and in a way that it will create a straight and flat surface from side to side. The over-tightening of the stabilizer bars may exert undue pressure on the tabs and cause damages to the JetSlide that are not covered by warranties



## “V” PLATE

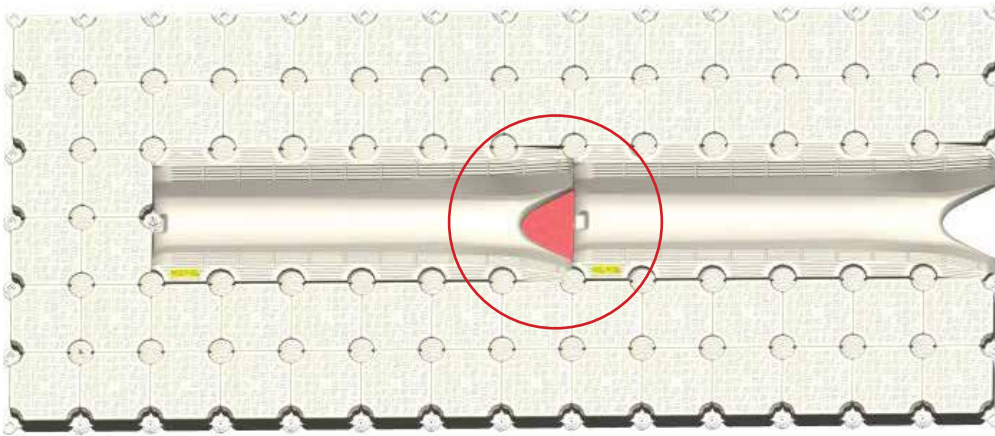

**Material/Composition :**  
 HDPE

**Needed tools :**  
 Halen key



## OVERVIEWS

You'll notice that the installation of in line JetSlides leaves a gap (in red on the attached image) at the V of JetSlide. To fill the gap you must install a V-plate which can be simply screwed under the JetSlide. It is very important for the safety of users. Candock Inc. disclaims all liability for accidents if the V plate is not installed. **BEWARE, THIS PLATE MUST NOT BE INSTALLED ON THE FIRST JETSLIDE.**

## ASSEMBLY PROCEDURE

1-Simply secure the plate against the JETSLIDE using the supplied hardware. (6)

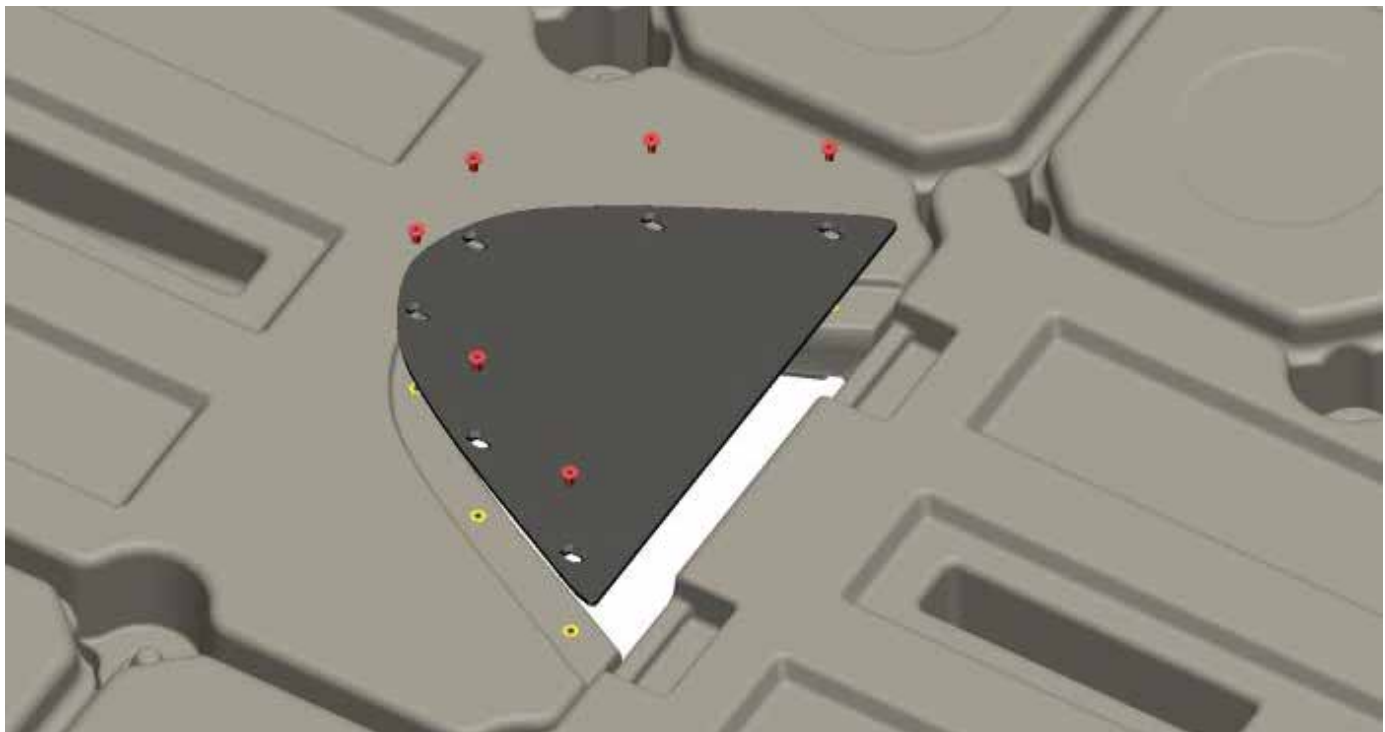

## SAFETY PLATE ( 1,2 AND 3 CUBES )



### Material/Composition :

HDPE

### Needed tools :

15/16" key wrench

Key for nut

or

Ratchet key for nut + ratchet tool

### Needed accessories

(sold separately) :

5 TO 9 CANDOCK LUG CONNECTOR **JETSLIDE**

5 TO 9 CANDOCK SLIDING NUTS

4 TO 8 CANDOCK SPACERS

Depending on plate size.

## OVERVIEWS

These Safety Plates, available in 3 different sizes, have been created to accommodate intermediary boat length. Indeed, instead of forcing our customers to buy a second **JETSLIDE** to accommodate their boat's length, we came up with this efficient yet very affordable solution to create enough room for their boat hull without sacrificing the efficiency of our systems.

\*In use, the plate can deform slightly and keep this deformation. This deformation is expected and normal.

\*\*Please note that the surface of the safety plate can be slippery.

## ASSEMBLY PROCEDURE

- 1 - Place sliding nut on cube tabs.
- 2 - Place spacers on cube tabs to equalize the height with the highest cube tab.
- 3 - Put the safety plate without moving the spacers.
- 4 - Screw **CANDOCK LUG CONNECTORS JETSLIDE\*** on the fixation tab of the safety plate.

Based on the same mold as our regular **LUG CONNECTOR**, this model is simply exempt of the locking treads allowing it to be used as a regular bolt



### PRODUCT QUANTITIES ACCORDING TO PLATE SIZE\*:

PART NUMBER	DESCRIPTION	SAFETY PLATE 1 CUBE	SAFETY PLATE 2 CUBES	SAFETY PLATE 3 CUBES
CD075	SAFETY PLATE 1 CUBE	1	N/A	N/A
CD076	SAFETY PLATE 2 CUBES	N/A	1	N/A
CD077	SAFETY PLATE 3 CUBES	N/A	N/A	1
LK 703016	CANDOCK SPACER	4	6	8
LK 703013	CANDOCK SLIDING NUT	5	7	9
LK 703015	LUG CONNECTOR <b>JETSLIDE</b>	5	7	9

\*According to an independent installation with plugs forward.

## PWC WINCH



### Material/Composition :

Zinc plated steel  
 Aluminum

### Needed tools :

9/16" key wrench  
 Key for nut  
 or  
 Ratchet key for nut + ratchet tool

### Accessories included with the winch

1 CANDOCK LUG CONNECTOR  
 1 CANDOCK NUT  
 1 Aluminum mounting bracket  
 1 Pulling winch ( 400 lbs capacity )  
 equipped with a 15 ' strap and 1 hook.

## OVERVIEWS

Winch to be used mainly with the Jetslide system to help launch your PWC. It can be installed in front to pull it or on the sides for launch manoeuvres.

## ASSEMBLY PROCEDURE

- 1 - Depending on position of the assembly, adjust the angle of the winch on the plate using appropriate holes.
- 2 - Install [CANDOCK LUG CONNECTOR](#) / MOUNTING BRACKET ASSEMBLY where the winch is needed.
- 3 - Complete by by securely fastening the [CANDOCK NUT](#) against the [CANDOCK LUG CONNECTOR](#) as describd in the [BASIC PRODUCTS OWNER'S MANUAL](#)

\*When positionned on the side of the assembly for back-up procedures, position the strap in a straight line with the front of the PWC.  
 ( as pictured on the image )

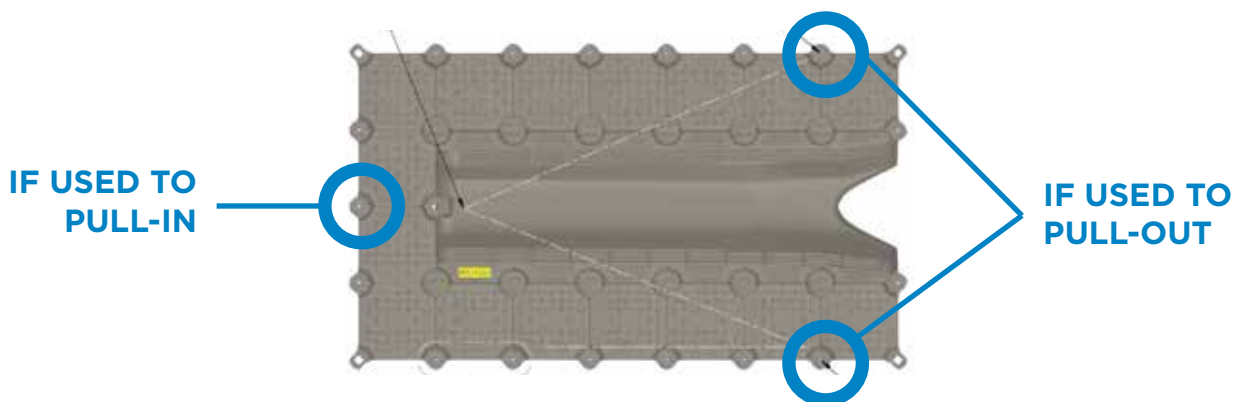

## WINCH JETSLIDE BOAT (MAX 3000PDS/1360KGS)



### Material/Composition :

SEACOAT™ corrosion protected steel  
 Aluminum

### Needed tools :

Key for nut  
 or  
 Ratchet key for nut + ratchet tool

### Accessories included with the winch

1 Aluminum mounting bracket  
 1 Pulling winch ( 1600 lbs capacity ) equipped with a 20 ' strap and 1 hook  
 1 20' long rope spliced at both ends.  
 1 Pulley  
 1 fastening carabiner  
 1 Shackle

### Other needed accessories (sold separately)

4 CANDOCK LUG CONNECTOR  
 4 CANDOCK NUT  
 1 ANCHORING RING

## OVERVIEWS

Sometimes, for a boat less than 1360kg / 3000lbs, a winch may be required to put the boat afloat.

NOTE: \*\*Turn the handle of the winch until the boat is enough in the water that it can back off on its own power. Do not back the boat too much; it could slide in the water by itself.

## ASSEMBLY PROCEDURE

1 - Install the ALUMINUM MOUNTING BRACKET where the winch is needed.

2 - Complete by securely fastening the CANDOCK LUG CONNECTOR and CANDOCK NUT against the cube tabs as described in the BASIC PRODUCTS OWNER'S MANUAL

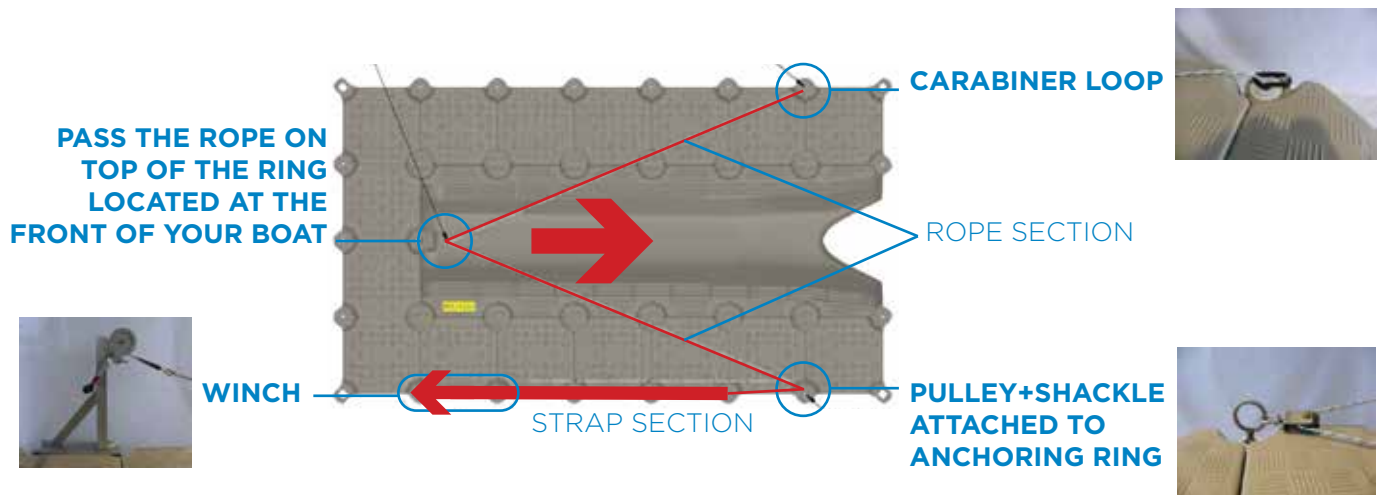

## CONFIGURATIONS AND ANCHORING GUIDELINES FOR “PWC” JETSLIDE SYSTEMS

### 1- THE 3 REGULAR CONFIGURATIONS

These are the 3 typical configurations for PWC / JETSLIDE assembly. Note that they can be paired-up without any complication. The following guidelines are mandatory for optimal ease of use and for warranty coverage policies.

#### REGULAR ASSEMBLY

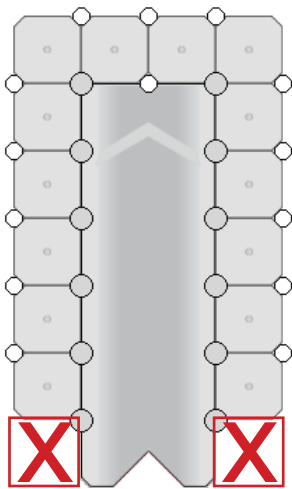

1

#### EXTRA SPACE/BOYANCY

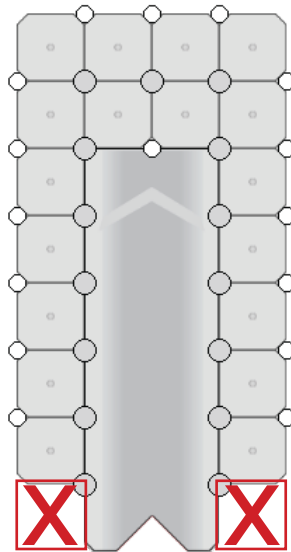

2

#### EXTRA BOYANCY

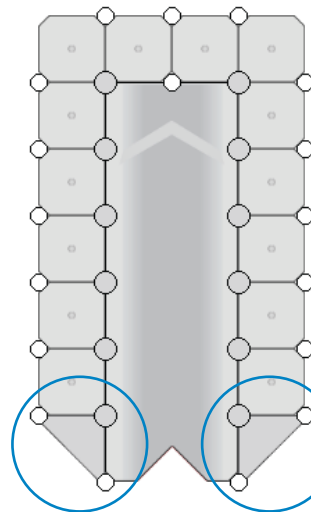

SEE PROPER ASSEMBLY  
 TECHNIQUE AT **PAGE. 5**

3

#### NOTES:

- Always keep the system symmetrical **left/right**.
- In doubt, please refer to your Candock representative.
- These guidelines are imperative to insure full warranty coverage**
- Although we advocate 2 rows of cubes in between each **JETSLIDE**, a multiple **JETSLIDE** assembly can be configured with either 1 OR 2 rows of cubes between each **JETSLIDE**. **Be aware of possible injuries if only 1 row is to be considered. Space in between the Jetskis will be limited.**
- Adding the 2 corner cubes at the back of the system OR 4 extra cubes in the front of the assembly is suggested for larger PWC or if extra space is needed at the front of the system.
- Under absolutely no circumstances regular G2 CUBES are allowed to be placed at the rear corners of our systems.**

#### MULTIPLE JETSLIDES ASSEMBLY

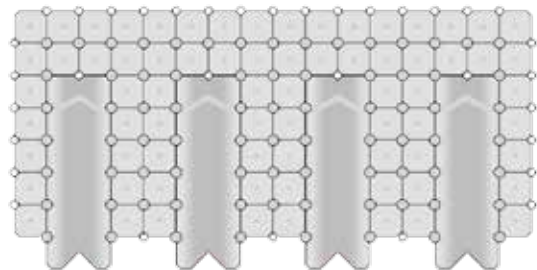

**CONFIGURATIONS AND ANCHORING GUIDELINES FOR “PWC” JETSLIDE SYSTEMS**

**2-THE 5 ANCHORING OPTIONS**

**2.1 - PILINGS**

**IDEAL ASSEMBLY**

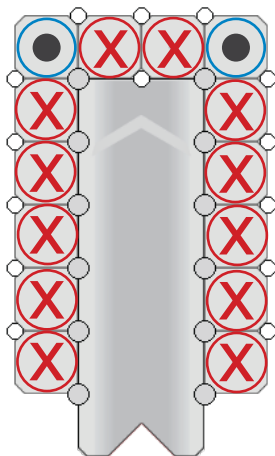

NOTES:

- Minimum of **2 PILES**
- Max. water depth is 2m / 6'.
- Always keep the anchoring symmetrical **left/right**.
- These guidelines are imperative to insure full warranty coverage
- In doubt, please refer to your Candock representative.

**2.2 - ANCHORING STRUTS**

**IDEAL ASSEMBLY**

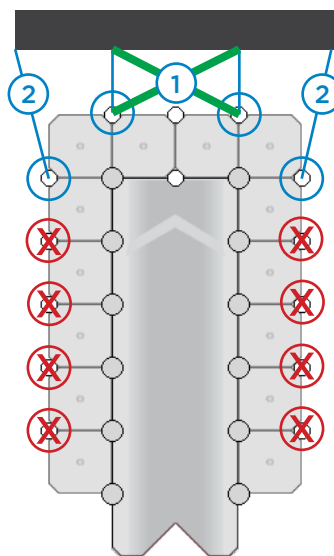

NOTES:

- Minimum of **2 STRUTS**
- Always keep the anchoring symmetrical **left/right**.
- If placed at position #1, use steel cable in “**X**” position between struts.
- If placed at position #2, steel cable are not needed.
- \*Beware of water level variation limitations +/- 2' (.75m).
- These guidelines are imperative to insure full warranty coverage
- In doubt, please refer to your Candock representative.

**2.3 - WALL ANCHORAGE**

**IDEAL ASSEMBLY**

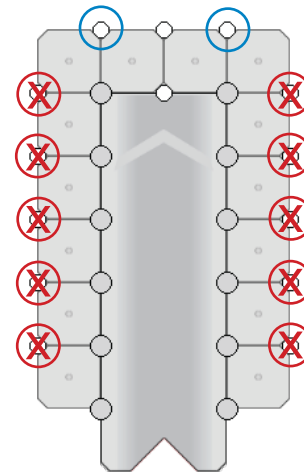

NOTES:

- Minimum of **2 WALL ANCHORAGE**
- Always keep the anchoring symmetrical **left/right**.
- THESE BRACKETS ARE STRICTLY FORBIDDEN IF NOT FIXED TO A FLOATING STRUCTURE AS THEY DO NOT ALLOW WATER LEVEL FLUCTUATION
- These guidelines are imperative to insure full warranty coverage
- In doubt, please refer to your Candock representative.

**CONFIGURATIONS AND ANCHORING GUIDELINES FOR “PWC” JETSLIDE SYSTEMS**

**2-THE 5 ANCHORING OPTIONS (SEQUENCE)**

2.4 - DOCK LEG SUPPORT

2.2 - ROPES AND CLEATS

**IDEAL ASSEMBLY**

**IDEAL ASSEMBLY**

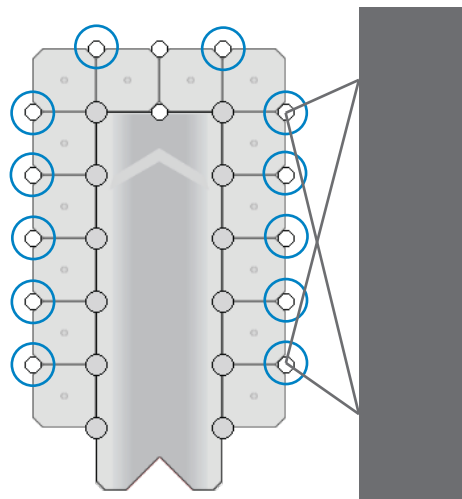
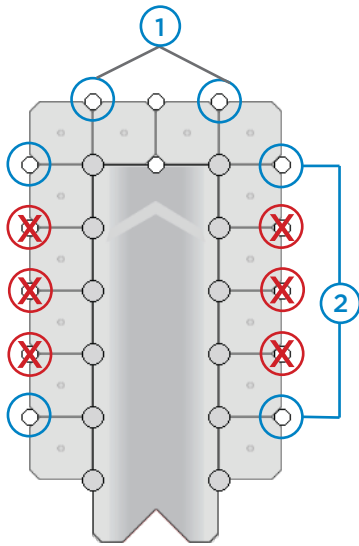

NOTES:

NOTES:

- To be installed on a fixed dock or structure. The 1 11/16” pile must also be driven into the sea bed.
- Minimum of 2 BRACKETS
- The piles are directly inserted through the dock leg support, then the cube tabs and then into the sea bed.
- Always keep the anchoring symmetrical left/right.
- These guidelines are imperative to insure full warranty coverage
- In doubt, please refer to your Candock representative.
- \*Do not use if water level can go over the fixed structure, at any given moment.

- Minimum of 2 FASTENING POINTS
- If placed on the side of the system, make sure the “rear” ropes will allow vertical movement when PWC is going up and down the JETSLIDE
- In doubt, please refer to your Candock representative.



## CONFIGURATIONS AND ANCHORING GUIDELINES FOR “BOAT” JETSLIDE SYSTEMS

### 1-THE CHART

These are the most common configurations for JETSLIDE assembly for boats under 6000lbs. Note that these will cover most of the possible situations but some exceptions may apply even if you abide to all of the following rules. Indeed, since January 2013, we are requesting that every JETSLIDE configuration gets approved prior to its installation. The following guidelines are mandatory for optimal ease of use and for warranty coverage policies. Please act accordingly.

BOAT LENGTH		BOAT WEIGHT		JETSLIDE	CUBE ROWS	SAFETY PLATE			V-PLATE	AIR ASSIST	STIFFENING BEAMS
METRIC (M)	IMPERIAL (FT)	METRIC	IMPERIAL			SIDES AND FRONT	1 CUBE	2 CUBES			
0 - 3,5	0 - 11,5	< 565 kg	< 1250 lbs	1	1	-	-	-	-	-	-
3,5 - 4	11,5 - 13	< 565 kg	< 1250 lbs	1	1	1	-	-	-	-	-
3,5 - 4	11,5 - 13	< 1360 kg	< 3000 lbs	1	2	1	-	-	-	-	-
4 - 4,5	13 - 14,5	< 565 kg	< 1250 lbs	1	1	-	1	-	-	-	-
4 - 4,5	13 - 14,5	< 1360 kg	< 3000 lbs	1	2	-	1	-	-	-	-
4,5 - 5	14,5 - 16,5	< 565 kg	< 1250 lbs	1	1	-	-	1	-	-	-
4,5 - 5	14,5 - 16,5	565 - 910 kg	1250 - 2000 lbs	1	1	-	-	1	-	-	-
4,5 - 5	14,5 - 16,5	910 - 1360 kg	2000 - 3000 lbs	1	2	-	-	1	-	-	3
4,5 - 5	14,5 - 16,5	1360 - 1820 kg	3000 - 4000 lbs	1	2	-	-	1	-	1	4
4,5 - 5	14,5 - 16,5	1820 - 2270 kg	4000 - 5000 lbs	1	2	-	-	1	-	1	4
4,5 - 5	14,5 - 16,5	2270 - 2730 kg	5000 - 6000 lbs	1	2	-	-	1	-	1	5
5 - 6,5	16,5 - 21	910 - 1360 kg	2000 - 3000 lbs	2	2	-	-	-	1	-	3
5 - 6,5	16,5 - 21	1360 - 1820 kg	3000 - 4000 lbs	2	2	-	-	-	1	1	4
5 - 6,5	16,5 - 21	1820 - 2270 kg	4000 - 5000 lbs	2	2	-	-	-	1	1	4
5 - 6,5	16,5 - 21	2270 - 2730 kg	5000 - 6000 lbs	2	2	-	-	-	1	1	5
6,5 - 7	21 - 22,5	910 - 1360 kg	2000 - 3000 lbs	2	2	1	-	-	1	-	3
6,5 - 7	21 - 22,5	1360 - 1820 kg	3000 - 4000 lbs	2	2	1	-	-	1	1	4
6,5 - 7	21 - 22,5	1820 - 2270 kg	4000 - 5000 lbs	2	2	1	-	-	1	1	4
6,5 - 7	21 - 22,5	2270 - 2730 kg	5000 - 6000 lbs	2	2	1	-	-	1	1	5
7 - 7,5	22,5 - 24	910 - 1360 kg	2000 - 3000 lbs	2	2	-	1	-	1	-	3
7 - 7,5	22,5 - 24	1360 - 1820 kg	3000 - 4000 lbs	2	2	-	1	-	1	1	4
7 - 7,5	22,5 - 24	1820 - 2270 kg	4000 - 5000 lbs	2	2	-	1	-	1	1	4
7 - 7,5	22,5 - 24	2270 - 2730 kg	5000 - 6000 lbs	2	2	-	1	-	1	1	5
7,5 - 8	24 - 25,5	910 - 1360 kg	2000 - 3000 lbs	2	2	-	-	1	1	-	3
7,5 - 8	24 - 25,5	1360 - 1820 kg	3000 - 4000 lbs	2	2	-	-	1	1	1	4
7,5 - 8	24 - 25,5	1820 - 2270 kg	4000 - 5000 lbs	2	2	-	-	1	1	1	4
7,5 - 8	24 - 25,5	2270 - 2730 kg	5000 - 6000 lbs	2	2	-	-	1	1	2	5
8 - 9	25,5 - 30	910 - 1360 kg	2000 - 3000 lbs	3	2	-	-	-	2	-	3
8 - 9	25,5 - 30	1360 - 1820 kg	3000 - 4000 lbs	3	2	-	-	-	2	1	4
8 - 9	25,5 - 30	1820 - 2270 kg	4000 - 5000 lbs	3	2	-	-	-	2	1	4
8 - 9	25,5 - 30	2270 - 2730 kg	5000 - 6000 lbs	3	2	-	-	-	2	2	5

## CONFIGURATIONS AND ANCHORING GUIDELINES FOR “BOAT” JETSLIDE SYSTEMS

### 2-THE 4 POSSIBLE ANCHORING OPTIONS

#### 2.1 - PILINGS

##### IDEAL ASSEMBLY

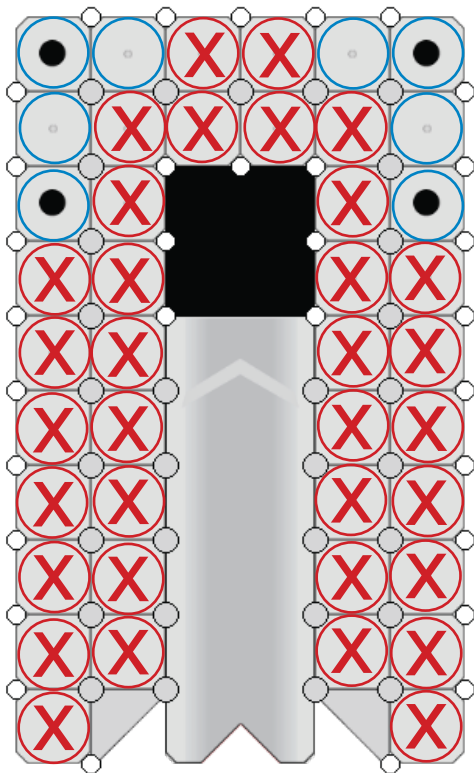

##### RULES:

- Minimum of 4 PILES should be considered at all time
- Max. water depth is 2m / 6'.
- If Using only PILINGS as anchoring technique, the size of the whole configuration is limited to 1 JETSLIDE along with 1 SAFETY PLATE 3 CUBES. If assembly requires a second JETSLIDE, a combination of multiple anchoring techniques will have to be adopted.
- Always keep the anchoring symmetrical left/right.
- As a safety or simply to optimize the efficiency and sturdiness of your system, regular ropes tied to cleats may also be added at the rear of the system
- Always leave a minimum of 1 regular cube between each G2 POST CUBE
- These guidelines are imperative to insure full warranty coverage
- In doubt, please refer to your Candock representative.

## CONFIGURATIONS AND ANCHORING GUIDELINES FOR “BOAT” JETSLIDE SYSTEMS

### 2.2 - ANCHORING STRUTS

#### IDEAL ASSEMBLY

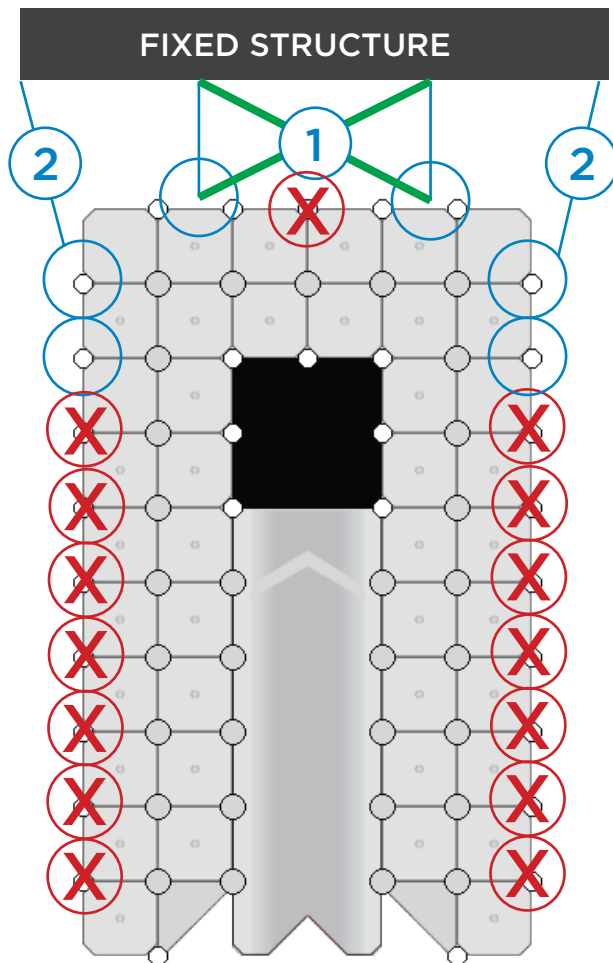

#### RULES:

-A Minimum of 2 ANCHORING STRUTS should be considered at all time

-If placed at position #1, use steel cable in “X” position between struts.

-If placed at position #2, steel cable are not needed.  
 \*Beware of water level variation limitations +/- 2' (.75m ).

-If Using only ANCHORING STRUTS as anchoring technique, the size of the whole configuration is limited to 1 JETSLIDE along with 1 SAFETY PLATE 3 CUBES. If the system requires a second JETSLIDE, a combination of multiple anchoring techniques will have to be adopted.

-Always keep the anchoring symmetrical left/right.

-As a safety or simply to optimize the efficiency and sturdiness of your system, regular ropes tied to cleats may also be added at the rear of the system

-These guidelines are imperative to insure full warranty coverage

-In doubt, please refer to your Candock representative.

## CONFIGURATIONS AND ANCHORING GUIDELINES FOR “BOAT” JETSLIDE SYSTEMS

### 2.3 - WALL ANCHORAGE

#### IDEAL ASSEMBLY

#### FLOATING STRUCTURE

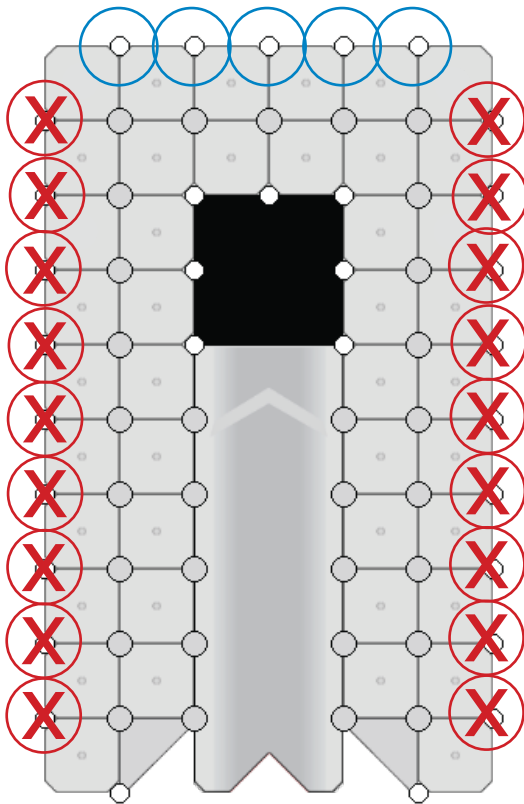

#### RULES:

-A Minimum of **3 WALL ANCRAGES** should be considered at all time

-If Using only **WALL ANCRAGES** as anchoring technique, **the size of the whole configuration is limited to 1 JETSLIDE along with 1 SAFETY PLATE 3 CUBES.** If the system requires a second **JETSLIDE**, a **combination of multiple anchoring techniques** will have to be adopted.

-As a safety or simply to optimize the efficiency and sturdiness of your system, regular ropes tied to cleats may also be added at the rear of the system

-Always keep the anchoring symmetrical **left/right.**

-These guidelines are imperative to insure full warranty coverage

-In doubt, please refer to your Candock representative.

## CONFIGURATIONS AND ANCHORING GUIDELINES FOR “BOAT” JETSLIDE SYSTEMS

### 2.4 - COMBINATIONS INCLUDING UNDER WATER ANCHORING POINTS

#### IDEAL ASSEMBLY

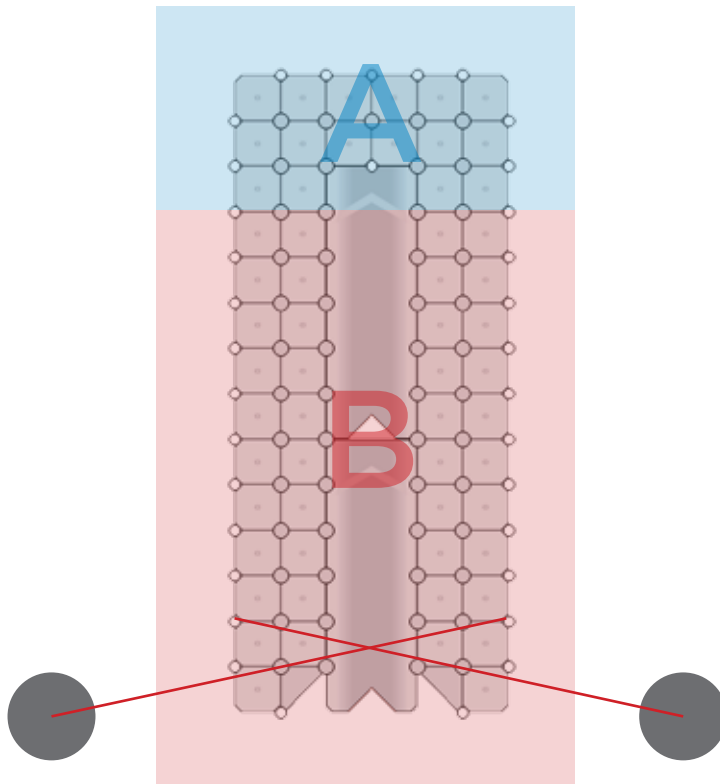

#### RULES:

- Make sure to abide to all pre-mentioned rules and guidelines.
- If boat is longer than 16.5 ft, a combination of anchoring products is required.
- If boat is heavier than 2000 lbs, a combination of anchoring products is required.
- The heavier the boat is, the stronger/heavier the REAR anchor points need to be.
- Anchoring items featured in zone **A** should always consist of either **PILINGS**, **ANCHORING STRUTS** or **WALL ANCHORAGES**.
- Anchoring items featured in zone **B** should always consist of either **UNDER WATER ANCHORING POINTS** or **ROPES AND CLEATS**.
- If placed on the side of the system, make sure the “rear” ropes will allow vertical movement when BOAT is going up and down the **JETSLIDE**
- A Minimum of 4 **ANCHOR POINTS** should be considered at all time.
- Always keep the anchoring symmetrical **left/right**.

-If using **UNDER WATER ANCHOR POINTS**, simply ask your dealer for recommended weight/type of anchors and special attachments. You will have to use galvanized or stainless steel 5/16”chain or good quality marine rope. The length will depend on water depth and variations of the water level. When using this type of anchoring, it is normal that the JetSlide moves slightly forward when entering the unit and backwards when exiting the unit. **This is why you need to check regularly the tightness of the chains to limit this movement.**

-These guidelines are imperative to insure full warranty coverage

-In doubt, please refer to your Candock representative.

## CONFIGURATIONS AND ANCHORING GUIDELINES FOR “BOAT” JETSLIDE SYSTEMS

---

### IMPORTANT NOTIONS

1-The **JETSLIDE SYSTEM FOR BOATS** can simply be attached to an existing dock using **WALL ANCHORAGES\*** (\* If fixed to **FLOATING STRUCTURE ONLY** ), **ANCHORING STRUTS** or a custom-made bracket that will be approved beforehand by an authorized Candock representative. Regular ropes and cleats may be also consist of anchoring/fixing accessories but we suggest that the watercraft using the systeme is under 1500 lbs.If you tie the **JETSLIDE SYSTEM FOR BOATS** to an existing dock, make sure that the dock is sturdy enough to resist the forward and backward movement generated by the watercraft when it enters or goes down the system.

2-The **JETSLIDE SYSTEM FOR BOATS** can also be added to an existing Candock system. Make sure that the dock is anchored well enough to resist the forward and backward movement generated by the watercraft when it enters or goes down the JetSlide.