



## Accessories

---

# -OWNER'S MANUAL-

TABLE OF CONTENT

CANDOCK BUMPERS	P.2
VERTICAL BUMPER	P.3
CANDOCK CLEAT ( REGULAR AND REINFORCED )	P.3
G2 CLEAT / CONNECTING PIN	P.4
H.D. BOLLARD TYPE CLEAT	P.5
<b>WHITE</b> L.E.D. LIGHT SYSTEMS	P.6
<b>R.G.B.</b> L.E.D. LIGHT SYSTEMS	P.9
CANDOCK BENCH	P.14
PIVOTING AND REVOLVING BENCH	P.15
CANDOCK SOFA	P.16
CANDOCK SLIDE	P.17
CANDOCK DIVING BOARD	P.18
G2 STORAGE CUBE	P.19
DOCK BOX	P.19
CANDOCK HANDRAIL POSTS	P.20
ALUMINUM HANDRAIL POST	P.22
OUTBOARD ENGINE SUPPORT	P.22
CANDOCK LADDER	P.23
SERVICE PEDESTAL	P.24
DOUBLE LAYER KIT	P.25
SUPPORT FOR MOURING WHIP	P.26
MISCELANIOUS -G2 CONNECTING PIN W/ 5/8" THREADED ROD - <b>CONCRETE FILLED</b> -	P.27
-G2 CONNECTING PIN W/ 3/8" THREADED ROD	P.27
-G2 CONNECTING PIN W/ 1/2" THREADED ROD	P.28
-G2 CONNECTING PIN W/ MULTI-BASE ADAPTOR.	P.29

**\*\*\* Note that it is preferable to consult the manual on a COLORED printed version, or directly on your computer screen\*\*\***

\*The following instructions are guidelines to be followed. Candock will not be responsible for damages incurred by the non-compliance to these guide lines. All distributors are required and responsible to provide theoretical and practical training to clients on the complete use of the different dock systems. Candock inc. can not be held responsible in any way for any damages resulting from the fact that the client has not received adequate training.

## CANDOCK BUMPERS

Available color is WHITE  
Other colors also available upon special request.



**Material/Composition :**  
Polypropylene + special compound

**Components :**  
1 Bumper and 1 **CANDOCK NUT**

**Needed tools:**  
-Key for nut  
or  
-Ratchet key for nut

## ASSEMBLY PROCEDURE

-Simply insert the bumper into the cube tabs and secure it by screwing the provide **CANDOCK NUT**.

-Make sure to insert needed spacers if the top and bottom tabs are not right on top of each other.

**Example: if installing the bumper on tabs #1 and #4, add 2 **CANDOCK SPACERS** in-between tabs.**



## VERTICAL BUMPER



**Material/Composition :**  
Aluminum and PVC

**Components :**  
1 PVC Bumper  
1 Aluminum structure  
1 Nut+Bolt set

**Needed tools:**  
-Key for nut  
or  
-Ratchet key for nut  
-1 1/8" wrench key

**Needed accessories to install the product ( sold separately ):**

1 **CANDOCK LUG CONNECTOR**  
1 **CANDOCK NUT**

## ASSEMBLY PROCEDURE

1-Simply insert the **CANDOCK LUG CONNECTORS** into the cube tabs wherever the bumper is needed. Secure by screwing the proper **CANDOCK NUTS** with proper toolings. Make sure to insert needed spacers if the top and bottom tabs are not right on top of each other.

**Example: if installing the bumper on tabs #1 and #4, add 2 CANDOCK SPACERS in-between tabs.**

2-Lay the bumper in place and then insert the provided bolt through the whole assembly. Secure by screwing the 1 1/8" bolts in place

## CANDOCK CLEAT ( REGULAR AND REINFORCED )

### REGULAR

Available color is WHITE



**Material/Composition :**  
High-density polyethylene resin

**Components :**  
1 **CANDOCK CLEAT**  
1 **CANDOCK NUT**

**Needed tools:**  
-Key for nut  
or  
-Ratchet key for nut

### REINFORCED

Available color is WHITE



\*CONCRETE FILLED

**Material/Composition :**  
High-density polyethylene resin  
Concrete

**Components :**  
1 **CANDOCK CLEAT**  
1 **CANDOCK NUT**  
-Concrete

**Needed tools:**  
-Key for nut  
or  
-Ratchet key for nut

## ASSEMBLY PROCEDURE

1-Simply insert the **CANDOCK CLEAT** into the cube tabs wherever it is needed. Secure by screwing the proper **CANDOCK NUTS** with proper toolings. Make sure to insert needed spacers if the top and bottom tabs are not right next to each other. Also beware of its orientation when installing the cleat, the projecting portion of the cleat should be placed seaward.

**Example: if installing the bumper on tabs #1 and #4, add 2 CANDOCK SPACERS in-between tabs.**



## G2 CLEAT / CONNECTING PIN

Available colors are GREY, BEIGE, BLUE and BLACK  
 Other colors also available upon special request.

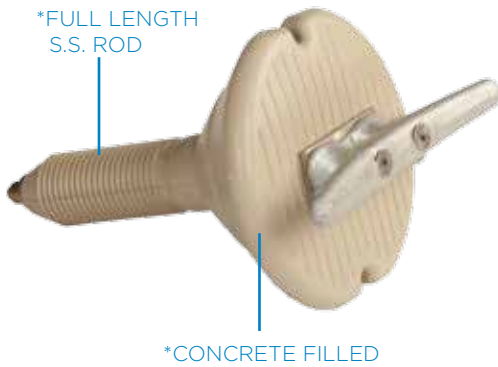

### Material/Composition :

Hot dipped aluminum  
 Concrete

### Dimensions :

L : 24 cm (9.6") x W: 17.2 cm (6.88")  
 Shaft diameter : 4.547 cm (1.819")

### Wall thickness:

.0750 cm (0.300")

### Components :

- 1 G2 CONNECTING PIN
- Hot dipped aluminum cleat
- Concrete
- Stainless steel rod

## ASSEMBLY PROCEDURE

- 1-During assembly process, always initiate the screwing process by hand. By doing so, pre-mature wear and tear will be prevented.
- 2-When the pins are properly inserted, proceed by screwing manually using the manual key as a lever:



- 3-Make sure to securely tight the G2 CLEAT / CONNECTING PIN until snug, without over tightening it.

## H.D. BOLLARD TYPE CLEAT



**Material/Composition :**

316 Stainless steel

**Components :**

1 Stainless steel cleat BOLLARD TYPE

**Needed tools:**

-G2 key for pin "combo-pack"  
 -15/16" wrench key

**Needed accessories to install the product ( sold separately ):**

-4 G2 Connecting pins w/ 5/8" threaded rod -**CONCRETE FILLED**-

## ASSEMBLY PROCEDURE

- 1-Establish the the location of the future H.D. BOLLARD TYPE CLEAT.
- 2-Remove the 4 regular G2 CONNECTING PINS that are surrounding the selected cube.
- 3-Insert the 4 G2 Connecting pins w/ 5/8" threaded rod -**CONCRETE FILLED**-that are needed to fix the bollard cleat. Initiate the screwing process by hand. By doing so, pre-mature wear and tear will be prevented.
- 4-When the pins are properly inserted, proceed by screwing manually using the G2 key for pin "combo-pack" only .  
 \*\*\*Using a power drill is not recommended for the G2 Connecting pins w/ 5/8" threaded rod -**CONCRETE FILLED**-
- 5-Make sure to securely tight the G2 Connecting pins w/ 5/8" threaded rod -**CONCRETE FILLED**- until snug, without over tightening it.
- 6-Remove the nuts and washers from the G2 Connecting pins w/ 5/8" threaded rod -**CONCRETE FILLED**- and put the H.D. BOLLARD TYPE CLEAT in place.
- 7-Secure the cleat by screwing the nuts and washers back in place with a 15/16" wrench key. Furthermore, the use of "anti-sease" grease is strongly recommended.

NOTE: Do not install the H.D. BOLLARD TYPE CLEAT out the outskirts of your dock. Always bring it 1 cube inside the perimeter

## WHITE L.E.D. LIGHT SYSTEM



### Electricity Consumption :

-1.5 watt

### Dimensions :

-Length 1 7/8" ( 4.7625 cm )  
-Diameter 1" ( 2.54 cm )  
-Power supply 15" ( 38.1 cm )

### Needed tools:

-G2 key for pin "combo-pack"  
-Seal stretching tool  
-Philips head screw-driver  
-Wire stripper pliers  
-Wire-cutter pliers  
-"Vice-grip" pliers

### Components :

-Sealed light bulb  
-Perimeter seal for COVER  
-Connector  
-Main power supply cable ( #14-2 12 volts low voltage )  
-Transformer ( 56, 108 or 250 watts )

## TERMINOLOGY

### ① SEALED LIGHT BULB:

Custom design light-emitting diodes that are destined to light-up any **CANDOCK** dock, pontoon, platform or marina. Perfectly sealed and extremely durable, these light bulbs are the most reliable and practical solution to bring light to any **CANDOCK** floating structure. Consuming minor quantities of energy, these lights can be coupled to a conventional deep cycle 12 volts marine grade battery or to a conventional 120 volts power outlet.

### ② PERIMETER SEAL FOR COVER:

Flexible rubber seal that is used to securely hold the light bulbs in the cube **COVERS**

### ③ CONNECTOR:

2 pieced plastic connector that transmits the electrical power from the **MAIN POWER SUPPLY CABLE** to the light bulb.

### ④ MAIN POWER SUPPLY CABLE:

#14-2, low voltage, 2 multi strand wires electric cable

### ⑤ 12 VOLTS CONVERTER:

56, 108 or 250 watts, 120 volts input/12 volts output with on/off modes, integrated **light sensor**, water-resistant casing and timer. Also compatible with motion detectors MD-01.



## ASSEMBLY PROCEDURE

1-Proceed with cube assembly as stipulated in the [BASIC PRODUCTS OWNER'S MANUAL](#) without installing covers on the [G2 SERVICE CUBE](#) bases. ( see [G2 CUBE](#) and [G2 SERVICE CUBE](#) assembly procedures )

2-To set up the main 12v power cable, place it onto the path created by the service cube bases. Please use the cable provided by Candock or a 12v landscaping cable 14-2 low voltage, 2 multi strand wires.

**NOTE :** If you need to install side covers, we recommend that you immediately attach them to their base and leave them open.

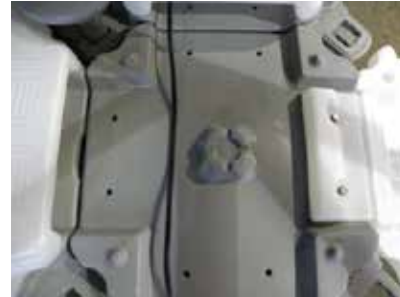

3-Insert the "perimeter seal for cover" in the pre-drilled hole of each covers.The seal has a small slot that allows a secure installation. You will see that if you push the ring completely on one side, it will be no longer inserted on the other side. This gap is intended so simply keep the ring in the center of the hole.



4-At this stage, we recommend that you connect the main power cable to the [12 VOLTS CONVERTER](#) supplied by Candock or other 12v converter. Switch on the converter, so that you can validate that the lights are operating properly as you connect them.

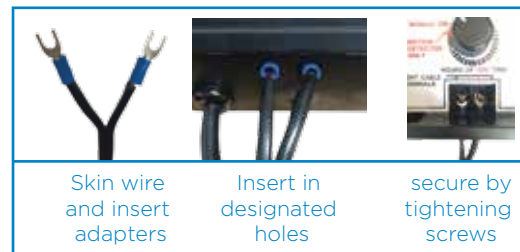

Skin wire and insert adapters

Insert in designated holes

secure by tightening screws

5-Separate the [CONNECTORS](#) that are included and take the lower part of the connector (the largest) and place the main power cord in the wider section. Lay the light cable into the connector in the smallest space. Put the upper part of the connector on the lower part, making sure the wires are laying flat. By using your two thumbs, please press firmly on both sides of the connector until you hear a click on each side of the connector. The light should normally come on. If not, please press harder on the connector( [the use of pliers is another good way to garanty a complete connection](#) ). If the light still does not turn on, make sure that the converter is powered on.



6-You can now put the [SEALED LIGHT BULBS](#) into the covers. Use the special tool to enlarge the rubber seal. Place the conical part in the ring and press the tool in for a few seconds. Hold the tool in place with one hand and keep the light in the other. Remove the tool quickly and immediately insert the light into the ring.





7-Gently push the light until the bottom of the light is at the same level as the ring. Position the light so that the wire is on the same side as the main power cable. Make sure that the wire of the light is aligned with one of the **small cavities** in the service base so that it is not crushed when the cover is in place.

8-Once all the lights are in place in the covers, you should put the covers in place.

9-Keep the converter powered on during this step to make sure that the connections are not damaged when installing the covers and that the lights turn off.

10-You can now close the converter and set it to the mode of your choice.



#### NOTES

A. The lights can be installed in the covers and the covers put in place as you go.

B. The lights are 1.5W and you must ensure that you do not exceed the capacity of your converter. Thus, a converter of 56w allows for 37 lights. ( $56w / 1.5 = 37$ ).

C. You should never install a cable longer than 100 m or 300ft, to prevent loss of power. If you must use more than 100 m/300ft, please use an additional converter.

D. Connectors are designed for a 14-2 low voltage power cable only.

E. If you need to remove a light that is already installed in a cover, do not remove it by pulling on the wire. Push the light completely inside the cover, remove the ring and then it will be easy to pull out the light from the cover.

## R.G.B. L.E.D LIGHT SYSTEM



### Electricity Consumption :

-1.5 watt

### Dimensions :

-Lenght 2 3/8" ( 6.0325 cm )  
-Diameter 1" ( 2.54 cm )  
-Power supply 15" ( 38.1 cm )

### Needed tools:

-G2 key for pin "combo-pack"  
-Seal stretching tool  
-Flat head screw-driver  
-Wire stripper pliers  
-Wire-cutter pliers  
-"Vice-grip" pliers

### Components :

-Sealed light bulb  
-Perimeter seal for COVER  
-Connector  
-Main power supply cable ( #14-2 12 volts low voltage )  
-Data cables and connectors  
-Programmable control box.

## TERMINOLOGY

### ① SEALED LIGHT BULB:

Custom design light-emitting diodes that are destined to light-up any **CANDOCK** dock, pontoon, platform or marina. Perfectly sealed and extremely durable, these multi-color light bulbs are the most reliable and practical solution to bring multi-color light to any **CANDOCK** floating structure. Consuming minor quantities of energy, these lights must be coupled to our customly fabricated **PROGRAMMABLE CONTROL BOX**.

### ② PERIMETER SEAL FOR COVER:

Flexible rubber seal that is used to securely hold the light bulbs in the cube **COVERS**

### ③ CONNECTOR:

2 pieced plastic connector that transmits the electrical power from the **MAIN POWER SUPPLY CABLE** to the light bulb.

### ④ DATA CABLES AND CONNECTORS:

Connectors that are acting as data purveyor between the **CONTROL BOX** and the **LIGHT BULBS** depending on the desired lighting mode and configuration.

### ⑤ MAIN POWER SUPPLY CABLE:

56 watts power, **120 volts input/12 volts output** with on/off modes, integrated **light sensor**, water-resistant casing and timer. Also compatible with motion detectors MD-01.

### ⑥ CONTROL BOX

56 watts power ( **63 lights capacity** ), **120 volts input** ( adaptable to every type of plugs, The blue wire being the negative one, the brown wire being the positive, and the yellow and green wire being the ground ), **12 volts output** with on/off mode and 10 different operating modes. ( **RED-GREEN-BLUE-FADE IN FADE OUT, FLASHING, RANDOM, MULTI-COLOR, TEC...**)

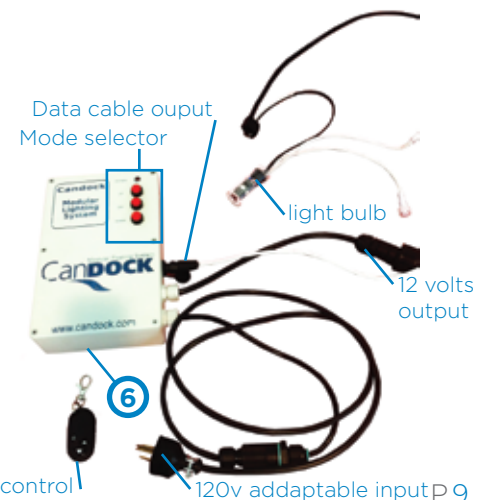
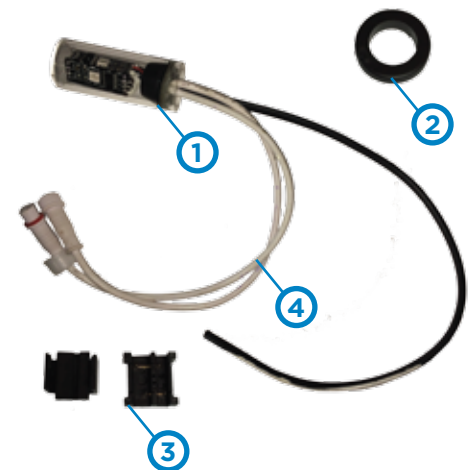

## ASSEMBLY PROCEDURE

1-Proceed with cube assembly as stipulated in the [BASIC PRODUCTS OWNER'S MANUAL](#) without installing covers on the [G2 SERVICE CUBE](#) bases. ( see [G2 CUBE](#) and [G2 SERVICE CUBE](#) assembly procedures )

2-To set up the main 12v power cable, place it onto the path created by the service cube bases. Please use the cable provided by Candock or a 12v landscaping cable 14-2 low voltage, 2 multi strand wires.

**NOTE :** If you need to install side covers, we recommend that you immediately attach them to their base and leave them open.

3-Insert the "perimeter seal for cover" in the pre-drilled hole of each covers.The seal has a small slot that allows a secure installation. You will see that if you push the ring completely on one side, it will be no longer inserted on the other side. This gap is intended so simply keep the ring in the center of the hole.

4-Track the following connector linked to the [CONTROL BOX](#), then split it in two by following the direction of the arrow indicated on it.

5-You must uninstall the part of the connector that is not linked to the [CONTROL BOX](#) (right side on previous picture) by gently removing the small white latch with a small flat screwdriver and by slightly turning the white part. It will then easily come out of the black part.

6-Unscrew the tip located at the other end of the connector. There are 3 small pieces inside.

7-Put the 12v power cable inside the connector by putting the different pieces as shown here:

8. Take out the cable enough on the other side of the connector to be able to link it to the previously removed white part. Split the cable on 3cm and rip on 1cm. Connect the wire bearing the writings to the connector bearing **L** and the otherwire to the **N** bearing . Screw in place solidly using the silver screws.

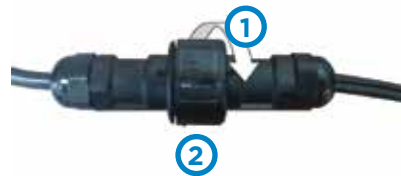
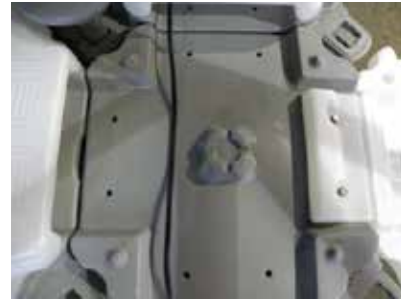

## ASSEMBLY PROCEDURE ( SEQUENCE )

---

9. By gently pulling on the wire, put the white part back inside the black part and turn to block it in place.

10. Close the other extremity of the connector by screwing the lid in place. Screw tightly (without exaggerating) to make sure it is sealed.

11. Take the black wire linked to the **CONTROL BOX** that has no connector at its end and connect it to a power plug adapted for your country. The blue wire being the negative one, the brown, the positive and finally, the yellow and green being the ground.



12. You are now ready to connect the lights together on the **MAIN POWER SUPPLY CABLE** and all-together with the **DATA CABLES AND CONNECTORS**. Beware, polarity must be respected to avoid damaging the light and/or the control box. **The part of main power wire bearing the writings must be linked to the side of the light wire of the light marked in white.**

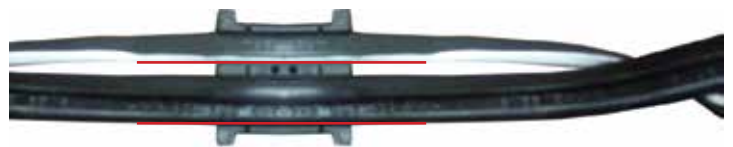

Separate the **CONNECTORS** that are included and take the lower part of the connector (the largest) and place the main power cord in the wider section. Each metallic part of the connector allows an electrical connection with a specific side of the wires on it. Make sure the wires lie such as shown in the following picture. The part of the wire of the main supply bearing writings must be linked to the side of the supply wire of the light marked in white. They must therefore be on the same side in their respective space. By using your two thumbs, press firmly on both sides of the connector until you hear a click on each side of the connector. If not, please press harder on the connector ( **the use of pliers is another good way to guaranty a complete connection** ).



13. You can now put the **SEALED LIGHT BULBS** into the covers. Use the special tool to enlarge the rubber seal. Place the conical part in the ring and press the tool in for a few seconds. Hold the tool in place with one hand and keep the light in the other. Remove the tool quickly and immediately insert the light into the ring.



ASSEMBLY PROCEDURE ( SEQUENCE )

14-The lights' power supply is now complete. You must now link the lights between each other so the communication can be made between them and the **CONTROL BOX**. Take the white wire of the control box that should normally already be linked to it and connect it to the first light of the series.

**NOTE:** These connectors can only be connected in one way. The only thing you now need to do is link the lights together using the white wires.



15-You can now close the lids. Position the light so the wires are lined up with the **small cavities** in the service base to avoid them being crushed when the lid is put in place.

16-At this step, you must open the control box by unscrewing the 6 screws that are on top. Gently remove the lid by paying attention not to disconnect the wires linking the base to the lid.

Inside you will find a selector that allows you to choose the appropriate voltage. Put the selector in the right position. (Beware, selectors are very fragile). Locate the following selectors. This is where you need to select the number of lights used in the system.

The lower selector indicates **tens** and the above selector indicates **units**.

EXAMPLE.: 8 lights (**Above 8, Low 0**), 25 lights (**Above 5, Low 2**)

MAXIMUM NUMBER OF LIGHTS: 63.

When finished, close the lid and screw tightly to preserve seal.

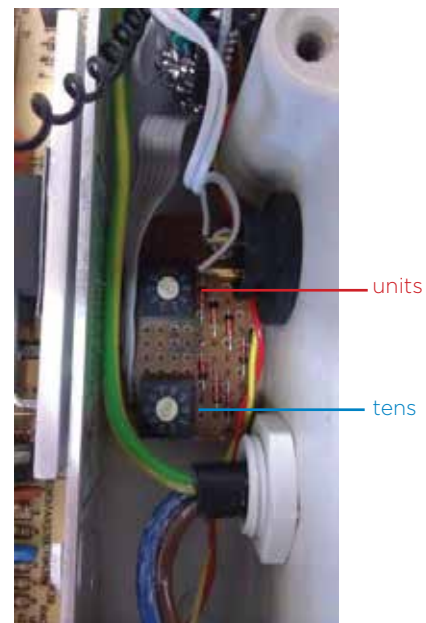

## ASSEMBLY PROCEDURE ( SEQUENCE )

---

17-Connect the control box to a supply source and activate the system by pressing on the OFF switch (it is possible that the system is already in function by default). By pressing a second time on the switch you are turning the system off. You may also use the remote control. Make sure all the lights are working. If a light is not working, press firmly on the connector to make sure the connexion is made properly. If this does not work, then check that the wires are placed correctly in the connector.

18. Finalize the set up of the lids while keeping the control box active to make sure the connections were not damaged during the installation of the lids and that lights turn off.

19-You can now choose from the 10 different operating modes that are available. Red, blue, green, yellow, red progressive lighting and turn off. Blue progressive lighting and turn off, green progressive lighting and turn off, yellow progressive lighting and turn off, rainbow effect, various lights / various colors.

Customized programming is possible and configurations are unlimited!!! Contact us for more information.

You can change the selections by using the UP and DOWN buttons on the control box or by using the remote control provided with the system (up or down arrow)

### NOTES:

- Lights can be installed and lids closed as you go along.
- You must never install a cable of more than 100m or 300ft, to avoid power losses.
- Contrary to white LED lights that do not have any polarity, RGB lights must be connected in the correct way to avoid any damage. Please follow instructions accurately.
- Connectors are only conceived for a 14-2 low voltage power cable.
- If you must remove a light that is already installed in a lid, never remove it by pulling on the wire. Completely push the light inside the lid, remove the ring and then it will be easy to remove the light from the lid.

## CANDOCK BENCH

Available colors are GREY and BEIGE



### Material/Composition :

Marine grade Aluminum  
 Re-inforced polypropylene pannels

### Components :

2 G2 CONNECTING PIN W/ MULTI-BASE ADAPTOR.  
 2 bench frame units  
 2 Pannels

### Needed tools:

-G2 key for pin "combo-pack"  
 -1/2" wrench key

## ASSEMBLY PROCEDURE

- 1-Establish the the location of the future **CANDOCK BENCH** on the dock.
- 2-Remove the 2 regular **G2 CONNECTING PINS** that are under the bench future location.
- 3-Insert the 2 **G2 CONNECTING PIN W/ MULTI-BASE ADAPTOR.** that will act as support legs for the bench. Initiate the screwing process by hand. By doing so, pre-mature wear and tear will be prevented.
- 4-When the pins are properly inserted, proceed by screwing manually using the **G2 key for pin "combo-pack"** as a lever.

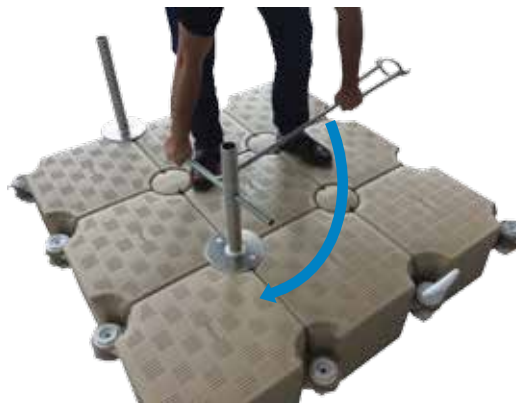

\*Insert the G2 key for pin "combo-pack" in the hole that is found at the end of the aluminum pipe.

- 5-Make sure to securely tight the **G2 CONNECTING PIN W/ MULTI-BASE ADAPTOR.** until snug, without over tightening it.
- 6-You can now assemble the bench parts together ( the 2 pannels and the 2 frame units ) with the 1/2" wrench key. While assembling the panels, make sure to use the aluminum re-inforced one for the seat and the regular one for the back rest. Make sure to properly align the mounting holes together while centering the pannels on the frame units. We rocommend to use "long nose" pliers to prevent the bolts from stripping the plastic inserts while screwing the nuts in place.
- 7-Simply insert the bench assembly into the **G2 CONNECTING PIN W/ MULTI-BASE ADAPTOR.**

## CANDOCK PIVOTING AND REVOLVING CHAIR



**Material/Composition :**  
 Marine grade Aluminum  
 Plastic and synthetic leather

**Components :**  
 1 G2 Multi base pin  
 1 revolving and folding chair

**Needed tools:**  
 -G2 key for pin "combo-pack"

### ASSEMBLY PROCEDURE

- 1-Establish the the location of the future **CANDOCK PIVOTING AND REVOLVING CHAIR BENCH** on the dock.
- 2-Remove the regular **G2 CONNECTING PIN** that IS under the chair's future location.
- 3-Insert the **G2 CONNECTING PIN W/ MULTI-BASE ADAPTOR**. that will act as support leg for the chair. Initiate the screwing process by hand. By doing so, pre-mature wear and tear will be prevented.
- 4-When the pin is properly inserted, proceed by screwing manually using the **G2 key for pin "combo-pack"** as a lever.

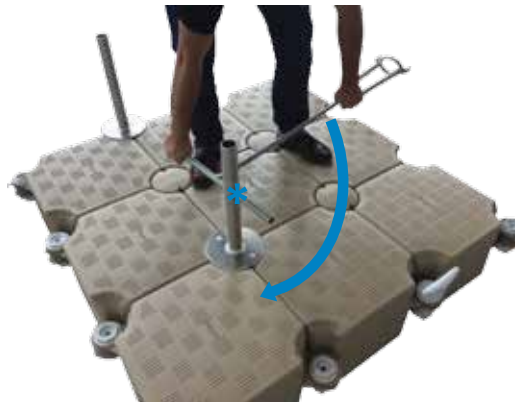

\*Insert the G2 key for pin "combo-pack" in the hole that is found at the end of the aluminum pipe.

- 5-Make sure to securely tight the **G2 CONNECTING PIN W/ MULTI-BASE ADAPTOR**. until snug, without over tightening it.
- 6-Simply insert the chair into the **G2 CONNECTING PIN W/ MULTI-BASE ADAPTOR**..



## CANDOCK SOFA



### Material/Composition :

Marine ply-wood and plastic  
 Synthetic exterior leather  
 (sun and water resistant)

### Components :

4 G2 connecting pins w/ 3/8" threaded rod.  
 2 sectional sofas

### Option :

2 slipcovers

### Needed tools:

-G2 key for pin "combo-pack"  
 -9/16" wrench key

## ASSEMBLY PROCEDURE

1-Establish the the location of the future **CANDOCK SOFA**.

2-Remove the 4 regular **G2 CONNECTING PINS** that are at the selected area.

3-Insert the 4 **G2 CONNECTING PIN W/ 3/8" THREADED ROD** that are needed to fix the **CANDOCK SOFA**. Initiate the screwing process by hand. By doing so, pre-mature wear and tear will be prevented.

4-When the pins are properly inserted, proceed by screwing manually using the **G2 key for pin "combo-pack"** .

\*\*\*Using a power drill is not recommended for the **G2 CONNECTING PIN W/ 3/8" THREADED ROD**

5-Make sure to securely tight the **G2 CONNECTING PIN W/ 3/8" THREADED ROD** until snug, without over tightening it.

6-Remove the nuts and washers from the **G2 CONNECTING PIN W/ 3/8" THREADED ROD** and put the **CANDOCK SOFA** in place. By doing so, the tip of each rods that are found on the head of the **G2 CONNECTING PIN W/ 3/8" THREADED ROD** will lightly mark the underneath surface of the **CANDOCK SOFA**. Remove the **CANDOCK SOFA** from its location and swith it on its back surface to have access to the "underneath" surface of the sofa. Simply locate the marks that have earlier been made on the surface and drill a 3/8" hole with a regular cordless drill. tilt the sofa back to its upright position and relocate to ist final position.

7-Secure it by screwing the nuts and washers back in place with a 9/16" wrench key. The bolts will be reachable from inside the sofa's hidden compartments, under the hatches seat cushions.



## CANDOCK SLIDE

Available colors are GREY, BEIGE and WHITE



**Material/Composition :**  
 Marine grade aluminum  
 Fiberglass  
 (sun and water resistant)

**Needed tools:**  
 -Ratchet key tool kit  
 -Cordless electric drill  
 -3/4" drill bit

**Components :**  
 6 rubber well nuts  
 2 aluminum plates  
 1 sectionnal ladder

### WELL NUTS



The “well nuts” must be as tight as possible into their holes to prevent them from spinning when screwing the bolts in them

## ASSEMBLY PROCEDURE

1-Pre-assemble the slide while referring to this video: <https://www.youtube.com/watch?v=nntD4Gs1Acc>

2-Establish the location of the future slide while making sure acces to the ladder and exit of the slide are oriented towards safe and secure locations.

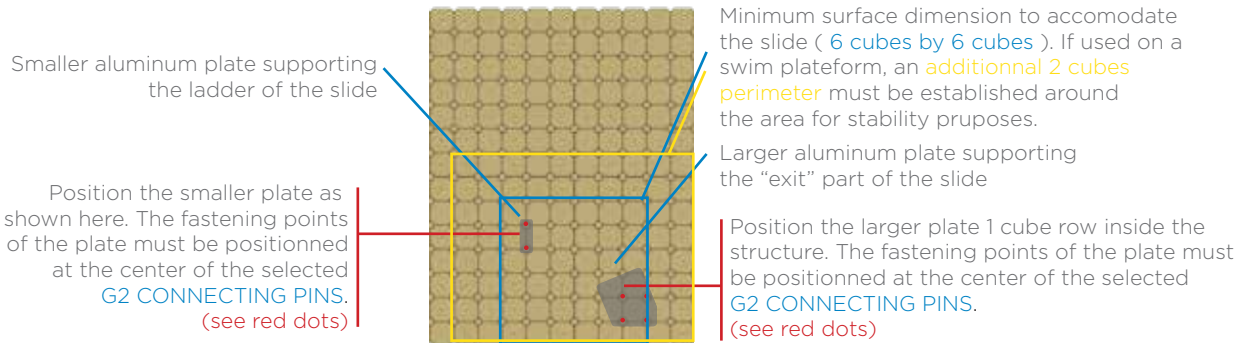

3-After choosing the future location of the slide and marking the designated **G2 CONNECTING PINS** ( for the ladder support and the “exit” part support ), simply drill a holeof 3/4” ( depending on the “well nut” diameter) and insert the “well nuts”.

4-You can now fasten the larger aluminum plate with the use of a “philips” head srewdriver.

5-Prior to fixing the smaller plate on the cubes, you must secure it to the bottom of the ladder by screwing the 4 nuts in place.

6-With the help of another person, gently tilt the slide upward so that it stands on its legs.

7- Align and insert the 4 legs of the slides on the larger aluminum plate.

8-Align the smaller aluminum plate over the designated “well” nuts to complete installation. Simply crew the 2 “philips” head screws through the designated “well nuts”.

## DIVE BOARD



**Material/Composition :**  
 Marine grade aluminum  
 ABS  
 (sun and water resistant)

**Components :**  
 1 Diving board fastening bracket  
 1 Diving board  
 1 Diving board base  
 -1 G2 POST CUBE

**Needed tools:**  
 -G2 key for pin "combo-pack"  
 -Cordless electric drill  
 -3/4" drill bit

Make sure to leave 2 rows of cubes between the base of the diving board and the edge of your dock

## ASSEMBLY PROCEDURE

1-Pre-assemble the diving board proceeding as mentioned:

A- Attach the diving board fastening bracket against the G2 POST CUBE as shown here:



Dismantle the bracket



Insert the rod from underneath the G2 POST CUBE



Complete by screwing the upper part back in place

2- Position the unit ( G2 POST CUBE and diving board bracket ) on your dock. You will have to dismantle a part of your dock to proceed. Install the unit like any other cube.

3-Secure the diving board's orientation by drilling a hole through the bracket and G2 POST CUBE and complete by screwing the bolt back in place. ( see the pre-drilled hole )

4-Install the diving board base against the bracket by screwing the 3 nuts.

5-Attach diving board to diving board base.

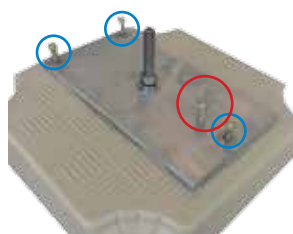

## G2 STORAGE CUBE

Available colors are GREY, BEIGE, BLUE and BLACK



### Material/Composition :

HDPE  
 ABS(sun and water resistant)

### Components :

-1 sealed hatche  
 -1 G2 CUBE

### Needed tools:

-G2 key for pin "combo-pack"

## ASSEMBLY PROCEDURE

1-See the regular G2 CUBE assembly procedure ins the CANDOCK'S "BASIC PRODUCTS OWNERS MANUAL".

\*Beware of latch orientation for product ease of use.

## DOCK BOX

Available color WHITE



### Material/Composition :

HDPE

### Components :

-1 lockable dock box  
 -1 G2 FASTENING PIN

### Needed tools:

-G2 key for pin "combo-pack"  
 -15/16" wrench key.

## ASSEMBLY PROCEDURE

1-Establish the the location of the future DOCK BOX.

2-Remove the 1 regular G2 CONNECTING PINS that is at the center of the selected area.

3-Remove the nut and washer from the G2 FASTENING PIN.

4-Insert the G2 FASTENING PIN that IS needed to fix the DOCK BOX. Initiate the screwing process by hand. By doing so, pre-mature wear and tear will be prevented.

5-When the pins is properly inserted, proceed by screwing manually using the G2 key for pin "combo-pack".

\*\*\*Using a power drill is not recommended for the G2 FASTENING PINS

6-Make sure to securely tight the G2 FASTENING PIN until snug, without over tightening it.

7-Secure it by screwing the nut and washer back in place with a 15/16" wrench key. The bolt will be reachable from inside the DOCK BOX.

\*Beware of latch orientation for product ease of use.

## CANDOCK HANDRAILS POSTS ( “SURFACE” OR “PERIPHERAL” )

Available colors are GREY, BEIGE, BLUE and BLACK

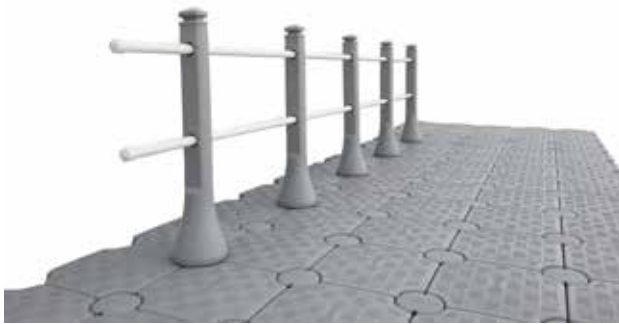

**Material/Composition :**  
 HDPE

**Other needed accessories with the SURFACE MODEL ( not included ) :**  
 -1 SLIDING NUT

**Other included accessories with the PERIPHERAL MODEL :**

- 1 STRENTENING SPACERS
- 4 CANDOCK SPACERS
- 1 NUT

**Needed tools:**

- G2 key for pin “combo-pack”
- Key for nut or Ratchet key for nut
- 1 Custom tool for the PERIPHERAL post

### ASSEMBLY PROCEDURE

#### IF USING THE “SURFACE” POST:

Before starting the installation of your CANDOCK HANDRAIL POST, you have to decide what type of horizontal handrail you’ll want to use on. Indeed, the post are shipped without being predrilled so depending on the diameter of your horizontal guards, you can drill the posts with the appropriate diameter “hole-saw”. This will insure a much sturdier and fine-tuned final assembly.

Establish the location of the future CANDOCK HANDRAIL POST. Remove the regular G2 CONNECTING PIN that is at the location of the future post. Insert the CANDOCK HANDRAIL POST. Initiate the screwing process by hand. By doing so, pre-mature wear and tear of the threads will be prevented. When the post is properly inserted, proceed by screwing manually using the custom tool for surface post. Make sure to securely tight the CANDOCK HANDRAIL POST until snug, without over tightening it.

Finalize your handrail system by passing the desired “horizontal supports”, ropes or pipes, through the holes that you have previously drilled in the posts.



#### IF USING THE “PERIFERAL” POST:

Before starting the installation of your CANDOCK HANDRAIL POST, you have to decide what type of horizontal handrail you’ll want to use. Indeed, the post are shipped without being predrilled so depending on the diameter of your horizontal guards, you can drill the posts with the appropriate diameter “hole-saw”. This will insure a much sturdier and fine-tuned final assembly. Establish the location of the future CANDOCK PERIPHERAL HANDRAIL.

Evaluate the position and numbers of SPACERS you will need to properly install the PERIPHERAL HANDRAIL. Keep in mind that a STRENTENING SPACER is mandatory if extra stiffenes is required for the post. The latter is to be inserted just before the CANDOCK NUT, which will secure the end of the post (treaded part). Make sure that you leave enough thread so that the CANDOCK NUT is fully engaged on the threads.

Insert the PERIPHERAL HANDRAIL and insert all necessary spacers (1 STRENTENING SPACER and 4 REGULAR CANDOCK SPACERS), complete by manually screwing a regular CANDOCK NUT. When the handrail is properly inserted, proceed by firmly screwing the CANDOCK NUT in place.

Finalize your handrail system by passing the desired “horizontal supports”, ropes or pipes, through the holes that you have previously drilled in the posts.

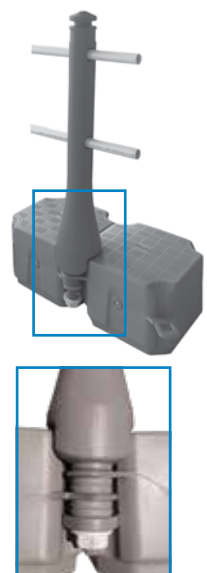

## CANDOCK HANDRAILS POSTS ( “SURFACE” OR “PERIPHERAL” MODEL)

---

### IMPORTANT NOTICE

---

1-For every installation using PVC tubing as handrails, we recommend to use appropriate glues and/or cement to secure each joints and caps that could be required. The use of screws or other types of hardware could result in breaking or cracking the PVC.

2-Every joints/connection, using ropes or rigid pipes, should always be positioned right in-between 2 neighboring posts. This will insure smooth lateral movements of the handrail through the posts.

### PRODUCT LIMITATIONS

---

-Regardless of the water conditions and main application of the floating dock, it is not recommended to use these handrails in conditions where waves are subjected to exceed 3 '(1m).

- When used with ropes, not rigid pipes, the holes diameter that are to be drilled in the posts should be at least 1/8 " (4mm) greater than the diameter of the rope that has been chosen.

- Unless installed in an environment completely protected from wave action, the ropes or pipes must have buffers of at least 18 " (45cm) at each end to allow free movement of the ropes OR pipes through the posts.

- We also recommend the use of a rope possessing high resistance to friction and abrasion.

-When used with rope instead of rigid pipes, the handrail system must not be considered as rail guard. Also note that the “PERIPHERAL” hand rail post is not designed to withstand the weight of a person, this is only a handrail and is only an aid to maintain balance while walking on the dock.

-To insure a safe and secure handrail system, a maximum space of 3 cubes (57" or 1.44m) is to be considered in-between each post.

- The handrail post is designed so that it perfectly accommodates a pipe with a diameter of 1.25" (3.175mm) so that it delivers a perfect fit between the posts and horizontal supports of the handrail system. Using pipes of greater diameter remains impossible and the use of a smaller diameter could limit the movement of the pipes inside the posts, thus prematurely damaging the system.

-When used with pipes and unless installed in an environment completely protected from wave action, the corners or “end section” of the handrail system (45 deg. ,90 deg. Regular ending portion of one handrail ) will not withstand waves over 12 " (30cm) for extensive periods. We therefore recommend to leave any corner section or “end section” as free as possible by adding the necessary buffers to your pipe measurements.

-If the “SURFACE” post is used, and a maximum of 2 cubes is left in-between each post and that rigid tubing handrails are used to complete the handrail system, the assembly may be used as a formal “rail-guard”. The maximal lateral force this assembly will withstand is set at 200lbs (91kg).

-If the “SURFACE” post is used, and a maximum of 2 cubes is left in-between each post and that rigid tubing handrails are used to complete the handrail system, the assembly may be used as a formal “rail-guard”. The maximal lateral force this assembly will withstand is set at 200lbs (91kg). If the latter is also paired with our “DOCK SURFACE STOPPING PLATES”, the whole floating structure will meet official

[United States ADA requirements\\*](http://www.ada.gov/2010ADASTandards_index.htm). ([http://www.ada.gov/2010ADASTandards\\_index.htm](http://www.ada.gov/2010ADASTandards_index.htm))

\* The previous configuration must not be installed in environments where waves can exceed 12" (30cm) for extensive period of time.

## ALUMINUM HANDRAIL POST

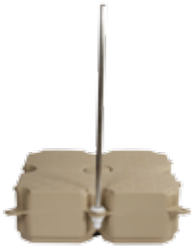

### Material/Composition :

Aluminum  
 HDPE

### Components :

-1 Aluminum post  
 -1 modified **CANDOCK LUG CONNECTOR**  
 -1 **CANDOCK NUT**

### Needed tools:

-Key for nut  
 or  
 -Ratchet key for nut

### WARNING:

-This handrail is not intended to be a "guard rail". Its sole purpose is to close a perimeter but it is not intended to prevent someone from falling off the dock.

### Other compatible accessories :

-Hand rail rope

## ASSEMBLY PROCEDURE

1-Establish the the location of the future **ALUMINUM HANDRAIL POST**.

2-**IF NEEDED**, evaluate the position and quantity of needed **CANDOCK SPACERS** considering that you should already have the 2 tabs available. In that case, 2 additional tabs need to be filled which means 2 **CANDOCK SPACERS**.

3-Insert the **ALUMINUM HANDRAIL POST**. Initiate the **CANDOCK NUT** screwing process by hand. This will prevent pre-mature wear and tear.

4-When screwing by hand is no longer possible, continue by screwing using the **key for nut** or **ratchet key for nut**

5-Make sure to securely tight the whole assembly until snug without over tightening it.

## OUTBOARD ENGINE BRACKET



### Material/Composition :

Aluminum  
 HDPE

### Components :

-1 Aluminum bracket  
 -2 **CANDOCK LUG CONNECTOR**  
 -2 **CANDOCK NUT**

### Needed tools:

-Key for nut  
 or  
 -Ratchet key for nut  
 -15/16" wrench key

### Other needed accessories

(  **sold separately**  ) :  
 -4 **CANDOCK SPACERS**

## ASSEMBLY PROCEDURE

1-Establish the the location of the future **OUTBOARD ENGINE BRACKET**.

2-Evaluate the position of the **4 needed CANDOCK SPACERS** considering that, for each supporting point, you should already have the 2 tabs of the surrounding cubes. To give more strenght to the whole assembly, even if your assembly is sitting on tabs 2 and 4, insert **CANDOCK SPACERS** at position # 1 and 4 to give as much strenght as possible to the bracket.

3- Start by installing the **CANDOCK BOLT + NUT** assemblies onto your dock against the tabs of the selected location. Initiate the **CANDOCK NUT** screwing process by hand. This will prevent pre-mature wear and tear. When screwing by hand is no longer possible, continue by screwing using the **key for nut** or **ratchet key for nut**.

4-Then, Insert the **OUTBOARD ENGINE BRACKET**.

5-Make sure to securely tight the whole assembly until snug without over tightening it.

### WARNING

Use of this product in combination with our modular floating dock system converts it into a boat and is therefore considered as is by transport Canada (the same situation could apply to other countries) and must respect the laws applying to boats. Our dock system is not designed for navigation and Candock Inc. disclaims any responsibility if it is used with an engine of any type whatsoever. It is the sole responsibility of the purchaser to comply with the laws in force.

## CANDOCK LADDER

Available colors are GREY and BEIGE



**Material/Composition :**  
 HDPE

**Components :**

- 2 uprights
- 1 pivoting lower part
- 2 4 G2 connecting pins w/ 3/8" threaded rod.

**Needed tools:**

- Key for nut
- or
- Ratchet key for nut
- G2 key for pin "combo-pack"
- 2 9/16 wrench key ( or 1 wrench key and 1 pair of pliers )

### ASSEMBLY PROCEDURE

1-Pre-assemble the ladder as shown on the manual included in the ladder box.

2-Establish the the location of the future **CANDOCK LADDER**.

3-Remove the regular **G2 CONNECTING PINS** that are located where you wish to install the ladder.

4-Prepare de dock for the ladder installation starting with:



#### 1-THE "INSIDE" SUPPORT POINTS ( FOR EACH SIDE OF THE LADDER )

A-Insert the 2 **G2 connecting pins w/ 3/8" threaded rod** that are needed to fix the other section of the ladder. Initiate the screwing process by hand. This will prevent pre-mature wear and tear.

B-When the pins are properly inserted, screw using the **G2 key for pin "combo-pack"** .

C-Make sure to securely tight the **GG2 connecting pins w/ 3/8" threaded rod** until snug, without over tightening it.

5-Position the ladder assembly on the dock following these steps and guidelines:

#### 2-THE PERIMETER SUPPORT POINTS ( FOR EACH SIDE OF THE LADDER )

A-Evaluate the position of the 4 **needed CANDOCK SPACERS** considering that, for each supporting point, you should already have the 2 tabs of the surrounding cubes. Regardless of tabs positionning, always fill the missing "layers" with spacers to fill each spot. This specification is simply to give more strenght to the whole assembly. So, as an example, if your assembly is sitting on tabs #2 and #3, insert **CANDOCK SPACERS** at position # 1 and # 4 thus making sure it is leveld with the top surface of the dock.

B-Insert the 2 treaded parts of the ladder into the chosen tabs. Initiate the **CANDOCK NUT** screwing process by hand. This will prevent pre-mature wear and tear

C-When screwing by hand is no longer possible, continue by screwing using the **key for nut** or **ratchet key for nut**

E-Complete ladder installation by screwing the 2 **brass nuts** as shown on this picture:

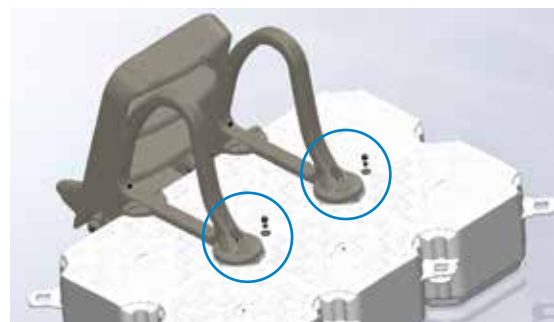



## SERVICE PEDESTAL

Available colors is WHITE



### Material/Composition :

- High quality 5052-H32 marine grade aluminum casing with 1/8" wall thickness
- Height: 45"
- Hubbell or MarineCo receptacles (standard 3), backlit for easy plug-in at night. (up to 200 AMPS MAX per pedestal)
- Powder coated white, inside and out, to guard against harsh marine conditions
- One 1/4 turn brass water bib
- One hose holder
- Low glare, photocell controlled, 7W fluorescent light LP-7 (frosted white lens), to illuminate the dock
- Latched door to protect circuit breakers
- Stainless steel hardware
- Power block w/ ratings from 175AMP to 500 AMP, 600V
- Square D circuit breakers

### Needed tools:

- G2 key for pin "combo-pack"
- Multiple screw driver and wrench key kit

### Needed accessories to install the product ( sold seperately ):

- 1 G2 SERVICE CUBE "BASE"
- 1 COVER ( SIDE OR REGULAR )
- Necessary hardware depending on where the pedestal will be installed

## TERMINOLOGY

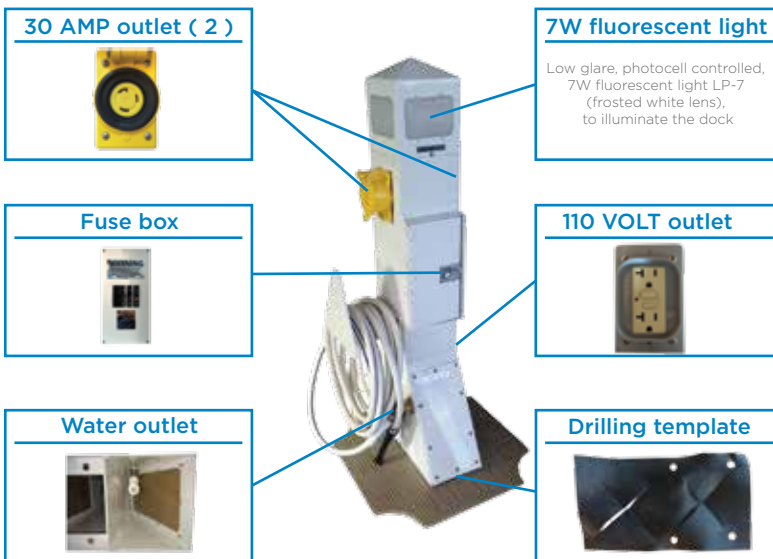

## ASSEMBLY PROCEDURE

1-Establish the future location of the pedestal ( Even if it can be installed on the outskirts of our docks, we suggest that pedestals get intalled one row of cube inside the perimiter to prevent any accident while servicing the pedestal )

2-Remove the COVER from the selected G2 SERVICE CUBE. Using the rubber drilling template, pre-drill the 4 holes right through the whole COVER. Also establish the diameter of the other needed holes (2) to easily pass electricity and water lines through the cover. Use proper "hole saw" diameter. With proper hardware, securely fasten the pedestal base to the cube COVER.

3-For water outlet, simply connect your water hose to the supplied connector using proper fittings and hardware.

**4-For all electrcity works and connections, we strongly suggest that you refer yourself to a a suitably qualified electrician to complete the work.**

## DOUBLE LAYER KIT



### Material/Composition :

- HDPE
- Stainless Steel 304

### Components:

- Stainless steel rod and hardware
- 2 **CANDOCK LUG CONNECTORS**
- 2 **CANDOCK NUTS**

### Needed tools:

- Key for nut
- or
- Ratchet key for nut
- 15/16" wrench key

## ASSEMBLY PROCEDURE

### BASIC 2 LAYER DOCK

- 1-Simply assemble both layers separately following proper instructions.  
 FOR THE TOP LAYER, make sure you don't build sections that are larger than 15 cubes assembly. This is simply to keep the section in formats that are easily manoeuvrable. When your bottom layer is completed, simply drag it in the water while keeping it close to shore. One by one, drag the top layer sections on top of the bottom layer. Before dragging additional sections, make sure to secure the previous ones with the **DOUBLE LAYER KITS**.
- 2-To install **DOUBLE LAYER KIT**, start by establishing their positions. These connectors should be installed every 3 to 4 cubes, on the outskirt of your dock.
- 3-When their positions are established, start by installing the **CANDOCK LUG CONNECTORS** and **CANDOCK NUTS** at every futur connecting points following proper guidelines.
- 4-Continue by inserting the stainless steel rods in each **CANDOCK LUG CONNECTORS** while aligning the bottom layer with the top layer.
- 5-When the top layer is passed, make sure to insert the **2 nuts and washers that will be needed between the 2 layers**.
- 6-Complete the installation by inserting the bottom nuts and washers and tightening all of the above properly.

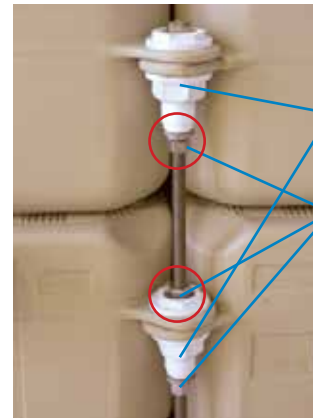

**CANDOCK LUG CONNECTORS AND NUTS**  
 SS nuts and washers

## SUPPORT FOR MOURING WHIP



### Material/Composition :

- Aluminum
- Stainless Steel

### Components:

- Aluminum plate
- G2 CONNECTING PIN W/ 1/2" THREADED ROD
- 1 LUG CONNECTOR
- 1 NUT
- \*\*\* MOURING WHIPS NOT INCLUDED\*\*\*

### Needed tools:

- G2 key for pin "combo-pack"
- Key for nut
- or
- Ratchet key for nut
- 15/16" wrench key

## ASSEMBLY PROCEDURE

### STEP 1

1-Establish the the location of the future SUPPORT FOR MOURING WHIP.

2-Remove the regular G2 CONNECTING PIN that is at selected area.

3-Replace the later by 1 G2 CONNECTING PIN W/ 1/2" THREADED ROD that will be needed to hold the support in place. Initiate the screwing process by hand. By doing so, pre-mature wear and tear will be prevented.

4-Make sure to securely tight the G2 CONNECTING PIN W/ 1/2" THREADED ROD until snug, without over tightening it.

5-Remove the nut and washer from the G2 CONNECTING PIN W/ 1/2" THREADED ROD and put them asside.



### STEP 2

1- Start by installing the CANDOCK BOLT + NUT assembly onto your dock against the tabs of the selected location.

2-Fasten your mooring whip base against the aluminum plate. You will therefore have access under the plate.

3-Take the whole assembly and fix it against the G2 CONNECTING PIN W/ 1/2" THREADED ROD and the CANDOCK BOLT + NUT assembly.

4-Complete by screwing the destined nuts and washers using proper key wrench.

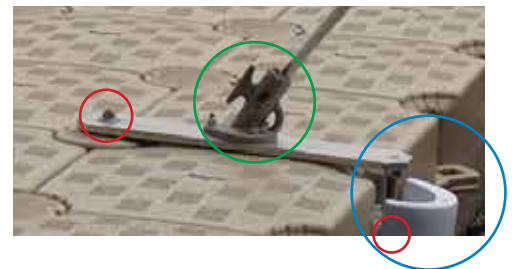

## G2 CONNECTING PIN W/ 5/8" THREADED ROD -CONCRETE FILLED-



**Material/Composition :**

- HDPE
- Stainless Steel threaded rod, bolts and washers.
- Concrete

**Needed tools:**

- G2 key for pin "combo-pack"
- 15/16" wrench key

**Required for:**

- H.D. BOLLARD TYPE CLEAT
- Any other structure that needs to securely fixed on our systems.

### ASSEMBLY PROCEDURE

- 1-During assembly process, always initiate the screwing process by hand. By doing so, pre-mature wear and tear will be prevented.
- 2-When the pins are properly inserted, proceed by screwing manually and/or mechanically with the pre-destined tools. For this product, the **KEY FOR G2 PIN "COMBO PACK"** is **mandatory** because of the prominent 5/8" treated rod.
- 3-Make sure to securely tighten the **G2 CONNECTING PIN W/ 5/8" THREADED ROD -CONCRETE FILLED-** until snug, without over tightening them.

## G2 CONNECTING PIN W/ 3/8" THREADED ROD



**Material/Composition :**

- HDPE
- Stainless Steel threaded rod and washers with brass bolt.

**Needed tools:**

- G2 key for pin "combo-pack"
- 15/16" wrench key

**Required for:**

- CANDOCK LADDER
- CANDOCK SOFA
- Any other structure that needs to securely fixed on our systems.

### ASSEMBLY PROCEDURE

- 1-During assembly process, always initiate the screwing process by hand. By doing so, pre-mature wear and tear will be prevented.
- 2-When the pins are properly inserted, proceed by screwing manually and/or mechanically with the pre-destined tools. For this product, the **KEY FOR G2 PIN "COMBO PACK"** is **mandatory** because of the prominent 3/8" treated rod.
- 3-Make sure to securely tighten the **G2 CONNECTING PIN W/ 3/8" THREADED ROD** until snug, without over tightening them.

## G2 CONNECTING PIN W/ 1/2" THREADED ROD

---



**Material/Composition :**

- HDPE
- Stainless Steel threaded rod and washers with brass bolt.

**Needed tools:**

- G2 key for pin "combo-pack"
- 15/16" wrench key

**Required for:**

- MOORING WHIPS SUPPORTS
- Any other structure that needs to securely fixed on our systems.

## ASSEMBLY PROCEDURE

---

1-During assembly process, always initiate the screwing process by hand. By doing so, pre-mature wear and tear will be prevented.

2-When the pins are properly inserted, proceed by screwing manually and/or mechanically with the pre-destined tools. For this product, the **KEY FOR G2 PIN "COMBO PACK"** is **mandatory** because of the prominent 1/2" treated rod.

3-Make sure to securely tighten the **G2 CONNECTING PIN W/ 1/2" THREADED ROD** until snug, without over tightening them.

## G2 CONNECTING PIN W/ MULTI-BASE ADAPTOR



### Material/Composition :

- HDPE
- Stainless Steel threaded rod and washers with brass bolt.
- Aluminum assembly

### Needed tools:

- G2 key for pin "combo-pack"

### Required for:

- CANDOCK BENCH
- Any other structure that needs to BE securely fixed on our systems.  
(I.E.: umbrella, table, chair...etc...)

## ASSEMBLY PROCEDURE

- 1-Establish the the location of the needed **G2 CONNECTING PIN W/ MULTI-BASE ADAPTOR**.
- 2-Remove the regular **G2 CONNECTING PIN** that is at the selected location.
- 3-Insert the **G2 CONNECTING PIN W/ MULTI-BASE ADAPTOR**. that will act as support for your accessory. Initiate the screwing process by hand. By doing so, pre-mature wear and tear will be prevented.
- 4-When the pin is properly inserted, proceed by screwing manually using the **G2 key for pin "combo-pack"** as a lever.

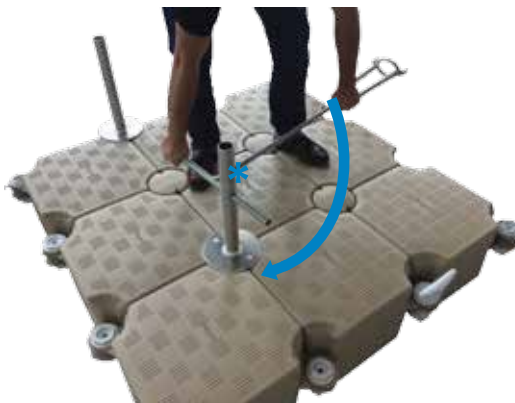

\*Insert the G2 key for pin "combo-pack" in the hole that is found at the end of the aluminum pipe.

- 5-Make sure to securely tight the **G2 CONNECTING PIN W/ MULTI-BASE ADAPTOR** until snug, without over tightening it.